

DEFINING EMI SOLUTIONS SINCE 1987
www.schlegelemi.com

NORTH AMERICA

Schlegel Electronic Materials, Inc.

1600 Lexington Ave
 Suite 236A Rochester NY 14606
 Tel No: +1 585-643 2000
 Fax No: +1 585-427 7216
 Email: schlegelemi.na@schlegelemi.com

EUROPE

Schlegel Electronic Materials, bvba

Slijpesteenweg 28
 8432 Middelkerke (Leffinge)
 Belgium
 Tel No: +32 59 560 270
 Fax No: +32 59 560 271
 Email: schlegelbe@schlegelemi.com

ASIA

Schlegel Electronic Materials (Far East) Limited

Unit 3, 3/F., Block A, New Trade Plaza,
 6 On Ping Street, Shatin, N.T., Hong Kong
 Tel No: +852-2686 9872
 Fax No: +852-2686 9728
 Email: schlegelemi@emeigroup.com

Schlegel Electronic Materials (Dongguan) Limited

No. 8 Qiaoxin Road, Qiaotou, Dongguan,
 Guangdong, China
 Postal Code: 523525
 Tel No: +86-769-8356 5686
 Fax No: +86-769-8334 5656
 Email: schlegelemi@emeigroup.com

Schlegel Electronic Materials (Dongguan) Limited – Shanghai Office

3/F., East, No. 4 Unit, 56 Meisheng Road,
 Waigaoqiao, P.T.Z., Pudong, Shanghai
 Postal Code: 200131
 Tel No: +86-21-5868 3383
 Fax No: +86-21-5868 3386
 Email: schlegelemi@emeigroup.com

Schlegel Electronic Materials (Far East) Limited – Taiwan Office

5F., No. 41, Lane 76, Rei Kuang Rd. Nei – Hu Dist,
 Taipei, Taiwan R.O.C
 Postal Code: 11466
 Tel No: +886-2-2793 9055
 Fax No: +886-2-2793 9501
 Email: schlegelemi@emeigroup.com

Fabric Over Foam

Profile Selection Guide

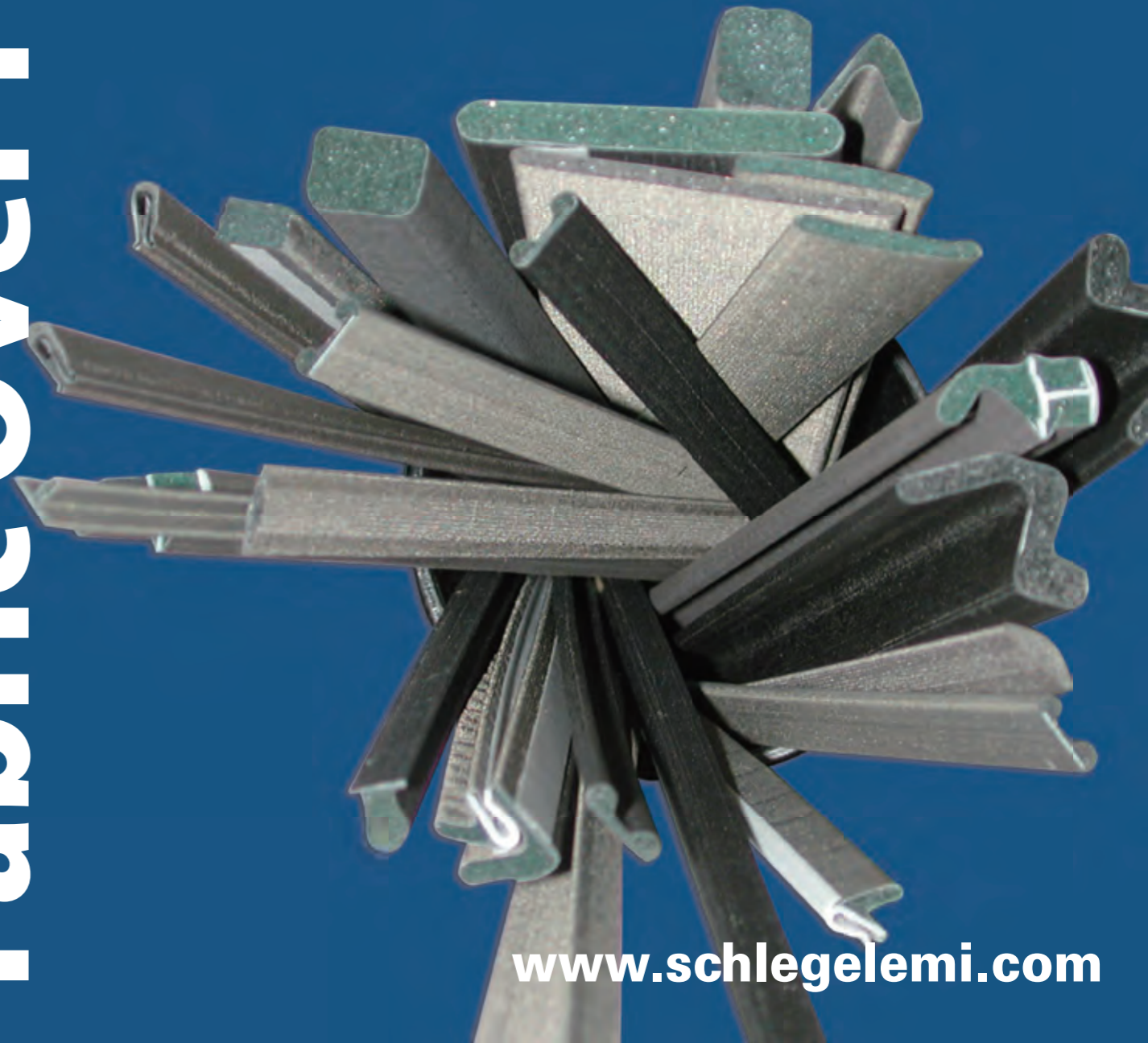
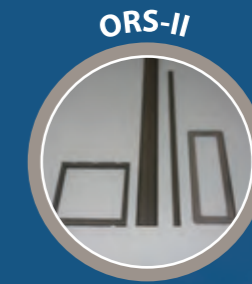
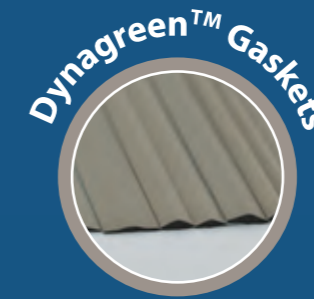

www.schlegelemi.com



As the inventor of conductive fabrics over foam shielding gaskets in 1987, Schlegel Electronic Materials (SEM) has always set the industry standard for highly flexible conductive fabrics. Over 20 years of continuous research and development on substrates, plating process and protective coatings confer today to our conductive fabrics improved shielding effectiveness, excellent environmental durability and abrasion resistance. References on the market, SEM's fabrics are used from grounding pads in consumer products to high frequency shielding gaskets in supercomputers. Fabric Over Foam technology provides continuous contact with applications which ensures consistent shielding efficiency at very high frequencies and is non-abrasive to plated and painted surfaces.

Fabric Over Foam

| | |
|--|--------------|
| Reference Guide | 1-2 |
| Conductive Materials Specifications | 3 |
| Characterization of EMI Shielding Gaskets | 4-5 |
| Part Number Guide | 6 |
| Profiles | 7-15 |
| Finishing Information | 16-18 |
| DynaShear / DynaGreen™ | 19-21 |
| Fabric Over Silicone EMI Gasket | 22-23 |
| Conductive Foam (CF) | 24 |
| ORS-II | 25-26 |
| Environmental and EMI Hybrid EEH Series | 27-30 |
| Conductive Tapes | 31-33 |
| D-Sub Connectors | 34-36 |
| Applications | |
| Influence of Conductive (D) and Non Conductive (R) Adhesive on Shielding Effectiveness for Fabric Over Foam Gaskets | 37 |
| SEM's Gaskets Attachment Options | 38-40 |

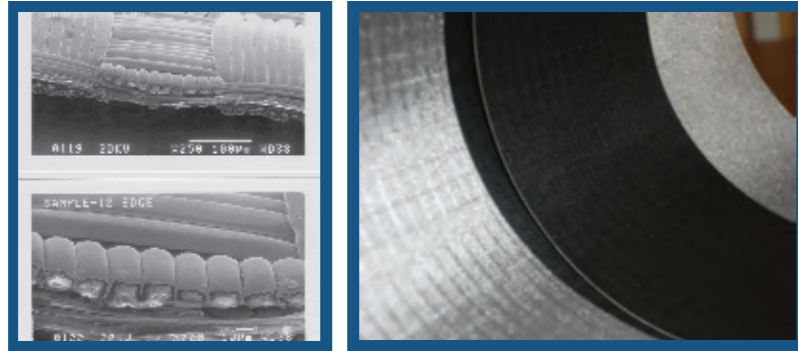

Schlegel Electronic Materials (SEM) has always been on the forefront of fabric over foam technology. And today fabric over foam continues to be at the core of our product lines. We offer a variety of fabrics including:

- 1: NiCu-C22: Nickel-Copper plated polyester ripstop fabric with Schlegel protective top coating.
- 3: NiCu-C70: Nickel-Copper plated polyester ripstop fabric with Schlegel protective top coating.
- 4: NiCu-C12: Nickel-Copper plated polyester plain weave fabric with Schlegel protective top coating.
- 7: SnCu-C50: Tin Copper plated nylon plain weave fabric with Schlegel protective top coating.
- 9: Ag-C2: Silver plated nylon ripstop fabric with Schlegel carbon coating.

| | NiCu-C70 | NiCu-C12 | Ag-C2 | SnCu-C50 | NiCu-C22 |
|---|------------------------------------|------------------------------------|--------------------------------------|------------------------------------|-----------------------------------|
| Fabric Type | PET Rip-stop | PET Plain Weave | PA 6 Rip-stop | PA 6 Plain Weave | PET Rip-stop |
| Top Coating-Basis | Acrylic | Acrylic | Urethane | Acrylic | Urethane |
| Surface Resistivity | $\leq 0.066 \Omega/\text{sq.}$ | $\leq 0.024 \Omega/\text{sq.}$ | $\leq 0.5 \Omega/\text{sq.}$ | $\leq 0.020 \Omega/\text{sq.}$ | $\leq 0.08 \Omega/\text{sq.}$ |
| Shielding Effectiveness (AVG.) | 96 dB Mil DTL 83528C | 97.4 dB Mil DTL 83528C | 95 dB Mil DTL 83528C | 95.3 dB Mil DTL 83528C | 95.76 dB Mil DTL 83528C |
| Contact Resistance (@1kg load) | 0.11 Ω -inch SEM LP 3001 | 0.08 Ω -inch SEM LP 3001 | < 1.00 Ω -inch SEM LP 3001 | 0.09 Ω -inch SEM LP 3001 | 0.2 Ω -inch SEM LP 3001 |
| Abrasion Resistance (cycles) | 800,000 ASTM D3886 | 1,000,000 ASTM D3886 | 800,000 ASTM D3886 | 1,000 ASTM D3884 | 1,000 ASTM D3884 |
| Core | All types | All types | All types | All types | All types |
| Compliances | 2011/65/EU (RoHS 2.0) | 2011/65/EU (RoHS 2.0) | 2011/65/EU (RoHS 2.0) | 2011/65/EU (RoHS 2.0) | 2011/65/EU (RoHS 2.0) |
| Galvanic Compatibility (Ni, Tin, Al, Zn) | SAE ARP 1481 classB | SAE ARP 1481 classB | SAE ARP 1481 classB | SAE ARP 1481 classB | SAE ARP 1481 classB |

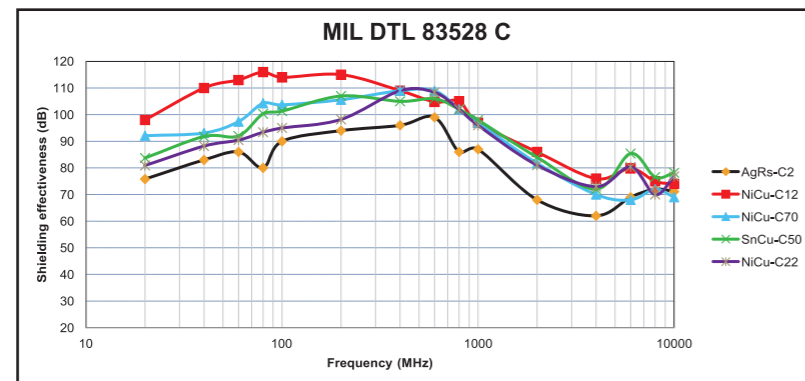

Schlegel Electronic Materials (SEM) is an active member of the IEEE P1302 Committee. This working group is in charge of the review of the methods to characterize Conductive gasket from DC to 40 GHz. Hereafter is a brief description of the main methods in use at **SEM**.

Mil DTL 83528 C.

This aperture attenuation method derived from the former Mil Std 285/IEEE 299 characterizes the shielding effectiveness (SE) of the gasket from 20 MHz to 10 GHz. The test set-up consist of a shielded room with an opening of 610/610 mm (24"/24") with one emitting antenna outside and a receiving antenna inside the room and two meters distance between antennas.

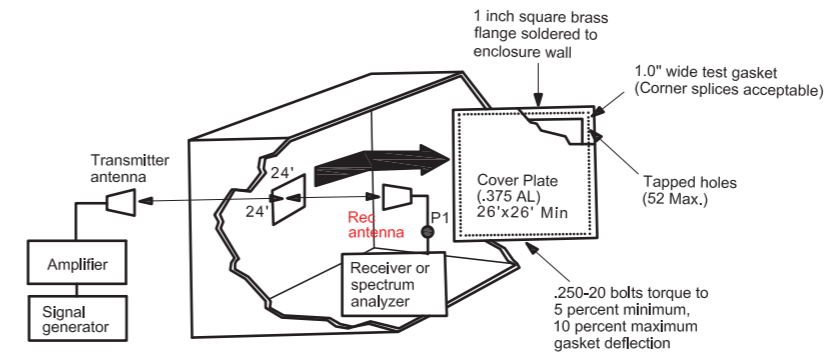

A first measurement is made from one antenna to the other through the opening and a second is made when the opening is closed by means of a metal plate with the gasket to be tested mounted around and compressed. The method measures the field before and after the metal / gasket and the shielding effectiveness of the gasket is: $20 \log E1/E2$ ($H1/H2$) or the difference between both measurements in dB from 20 MHz to 10 GHz. Measurements according to Mil DTL 83528C can be compared and especially if testing are carried out by an independent laboratory. The specification requires a minimum of 5 measurements per decade and SEM provide in its technical documentation the average value of the 15 measurements.

TEM-T and Ht cells

For the measurement of Shielding Effectiveness for small size gaskets, SEM is using TEM-T and Ht Cells. This is a non-standardized test method described in IEEE Std 1302 and used in R&D because of its good repeatability (1-3 dB). TEM-t is a TEM mode transmission line device simulating far field conditions. The square coaxial fixture of the TEM-t is cut in the middle so that a gasket holder compressing the gasket under test can be inserted between the two halves of the measuring equipment. The H-t cell is made by a set of two small loop antennas simulating the magnetic near field.

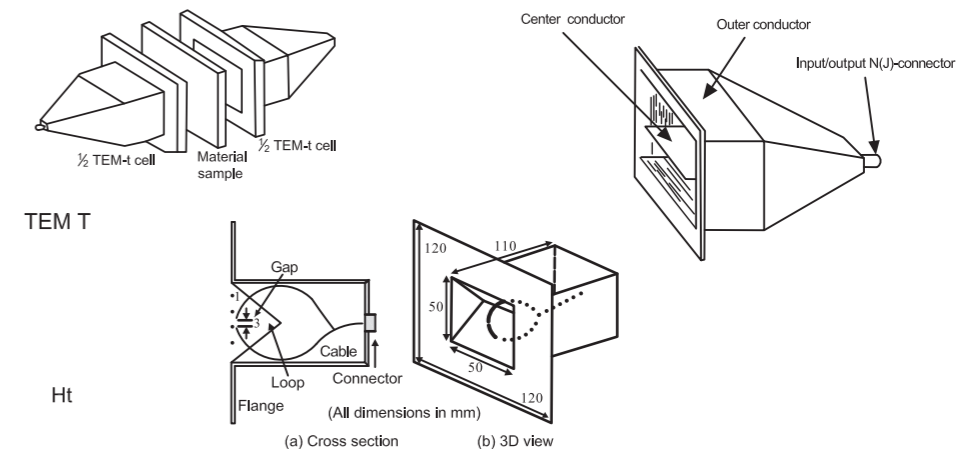

STRIPLINE METHOD (0.1-40 GHz)

Schlegel Electronic Materials (SEM), in partnership with the KULab REMI research group of the KULeuven (University of Leuven-Belgium), developed a new testing fixture to characterize the shielding effectiveness of conductive gaskets up to 40 GHz. The principle of this fixture is based on a method that was first introduced by Prof. B. Koerber to measure the radiated emission and susceptibility of Integrated Circuits (IEC 61967-8 and IEC 62132-8). The method utilizes a stripline antenna which closes over a PC-Board.

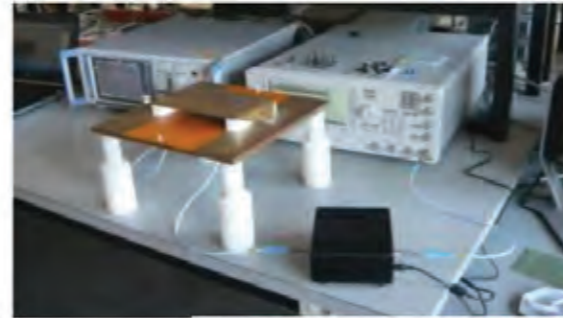
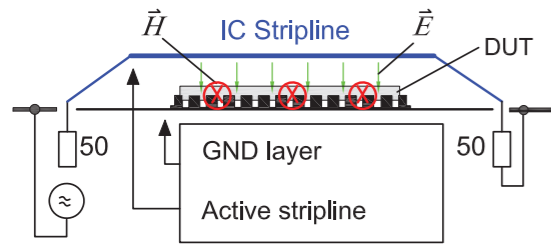

Stripline Fixture

In the new stripline fixture, the PC board with the IC under test is replaced by a small microstrip antenna embedded into a cavity within the ground plane. The cavity can be closed by means of a thick plate which compresses the gasket under test. A stripline antenna covers the set-up.

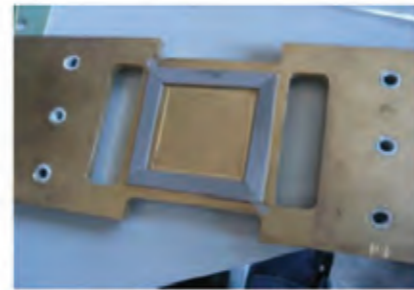
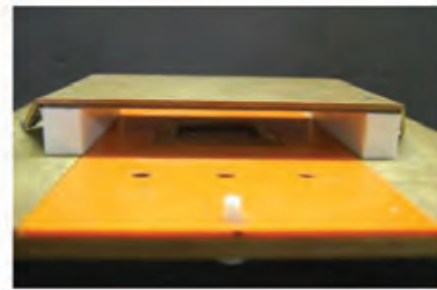
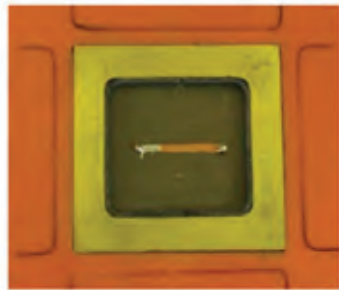

The testing procedure similar to IEEE 299 is as follows:

- a direct measurement from microstrip to stripline (signal before the shield).
- measurement of the closed cavity with the gasket under test (signal after the shield).
- Difference between both measurements in dB is the Shielding Effectiveness of the gasket .

The test method has been supported by a standard from SAE (Society of Automotive and Aerospace Engineers) under the reference SAE ARP 6248.

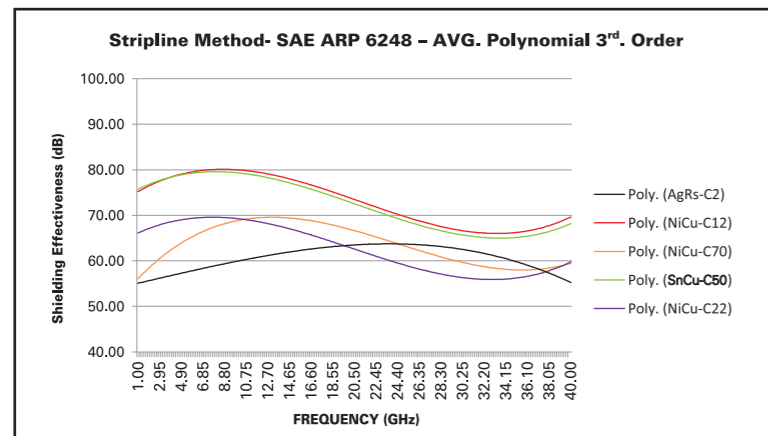

E XX X X X XXXXX HF

E = EMI Shielding

PROFILE SHAPE

FOAM TYPE

- 1 = UL 94 - HB recognized (Halogen free, HF, option is recommended.)
- 5 = Bromine free, UL 94 - V0 recognized
- 7 = Ultra Soft Foam, UL 94 - V0 recognized (Halogen free, HF, option is recommended.)
- 8 = Halogen free (IEC 61249-2-21) UL 94 - V0 recognized
- 9 = Closed Cell Polyurethane Foam UL 94 - HB recognized (Halogen free, HF, option is recommended.)
- S = High Temperature Resistance Halogen free (IEC 61249-2-21) Silicone Foam, UL 94 - V0 recognized

CONDUCTIVE FABRIC CLADDINGS

- 1 = C22 Nickel / Copper Fabric, Black Color
- 3 = C70 Nickel / Copper Fabric
- 4 = C12 Nickel / Copper Fabric, Best in Shielding
- 7 = C50 Tin / Copper Fabric, Special Galvanic Compatibility
- 9 = C2 Silver Fabric

FINISHING / ATTACHMENT SYSTEM

- = No Pressure Sensitive Adhesive (PSA)
- R = High Shearing Strength Tape
- H = High Temperature Resistance Tape
- Z = Wide Release Liner™ Tape
- J = Rivets Mount
- E = Die Cut
- K = Kiss Cut + PSA
- 2Z / 2R = 2 rows of PSA on the bottom side (If specifying 2Z or 2R, drop the first digit of the length field. i.e. 2R4800)

- W = Wide PSA
- N = Narrow PSA
- C = PSA in Center
- P = PSA on Inside Leg
- A = PSA on Adjacent Side
- B = PSA on Backside
- L = PSA on Lead Edge or Opposite Seam Side
- D = Conductive Adhesive (SEM recommends direct fabric contact over conductive adhesive.)

LENGTH IN INCHES

(all 0's if continuous)

- Examples: 04800 cut-to-length 48.00" [1219.2mm]
- 00138 cut-to-length 1.38" [35.1mm]
- 00152 cut-to-length 1.52" [38.6mm]

Some foam and fabric options may not be available with certain profiles. Please consult your SEM representative for details.

UL is a registered trademark of Underwriters Laboratories, Inc. UL tests are under the component program of Underwriters Laboratories, Inc. in specified claddings and thickness.

We may modify our Part No. structure for special custom made parts.

























The preceding information is believed accurate by SEM. In no event, however, shall SEM have any liability whatsoever for inaccuracies or omissions contained therein. In all cases, details and values should be verified by the customer. These products are covered by various U.S. and foreign patents.

Halogen free, IEC 61249-2-21, part number ends with HF. Non-halogen free part number ends without HF.

























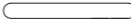

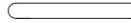
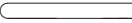
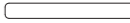
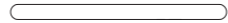
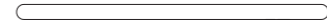
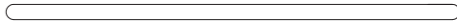
Think SEM For Shielding.













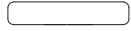
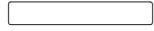
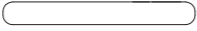
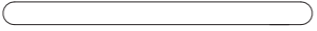
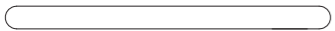

















www.schlegelemi.com

| | | | | | | |
|----------------------------------|---|---|---|--|---|-----------|
| Rectangle | E83 | E59 | ES1 | E88 | E91 | Rectangle |
| |  |  |  |  |  | |
| | 0.5mm x 4.0mm .020" x .157" | 0.5mm x 5.0mm .020" x .197" | 0.5mm x 6.0mm .020" x .236" | 0.5mm x 7.0mm .020" x .276" | 0.5mm x 10.0mm .020" x .394" | |
| | EU1 | ES2 | ET8 | EW5 | E1B | |
| |  |  |  |  |  | |
| 0.5mm x 15.0mm .020" x .591" | 0.5mm x 17.0mm .020" x .669" | 0.5mm x 22.5mm .020" x .886" | 0.7mm x 7.0mm .028" x .276" | 0.8mm x 6.0mm .031" x .236" | | |
| Rectangle | E37 | E03 | E12 | E06 | E11 | Rectangle |
| |  |  |  |  |  | |
| | 1.0mm x 3.0mm .039" x .118" | 1.0mm x 4.0mm .039" x .157" | 1.0mm x 5.0mm .039" x .197" | 1.0mm x 7.0mm .039" x .276" | 1.0mm x 10.0mm .039" x .394" | |
| | ET3 | E99 | ET4 | EJ6[†] | ET5 | |
| |  |  |  |  |  | |
| 1.0mm x 11.0mm .039" x .433" | 1.0mm x 13.0mm .039" x .512" | 1.0mm x 13.6mm .039" x .535" | 1.0mm x 15.0mm .039" x .591" | 1.0mm x 16.0mm .039" x .630" | | |
| Rectangle | E39 | E2C | E2E | EX3 | E1K | Rectangle |
| |  |  |  |  |  | |
| | 1.0mm x 18.0mm .039" x .710" | 1.0mm x 19.05mm .039" x .750" | 1.0mm x 21.84mm .039" x .860" | 1.0mm x 22.8mm .039" x .898" | 1.0mm x 22.9mm .039" x .902" | |
| | E29 | EC5[†] | | E97[†] | EW6 | |
| |  |  | |  |  | |
| 1.0mm x 25.4mm .039" x 1.000" | 1.0mm x 41.3mm .039" x 1.627" | | 1.2mm x 8.0mm .049" x .315" | 1.3mm x 2.3mm .051" x .898" | | |
| Rectangle | ER3 | EN6 | ED9 | E61 | EG2 | Rectangle |
| |  |  |  |  |  | |
| | 1.5mm x 3.18mm .059" x .125" | 1.5mm x 3.8mm .059" x .150" | 1.5mm x 5.0mm .059" x .197" | 1.5mm x 7.0mm .059" x .275" | 1.5mm x 10.0mm .059" x .390" | |

































[†] Contact your sales or customer service representative for details, special minimum order quantity may apply.

| | | | | | | |
|----------------------------------|---|---|---|---|---|-----------|
| Rectangle | EB5 | ET7 | E1M | EW4 | EA8[†] | Rectangle |
| |  |  |  |  |  | |
| | 1.5mm x 14.0mm .059" x .551" | 1.5mm x 16.2mm .059" x .638" | 1.5mm x 19.1mm .059" x .752" | 1.5mm x 25.4mm .059" x 1.000" | 1.5mm x 27.0mm .059" x 1.063" | |
| | EU2 | EU4 | E81 | EW9 | E77 | |
| |  |  |  |  |  | |
| 2.0mm x 2.5mm .079" x .098" | 2.0mm x 3.0mm .079" x .118" | 2.0mm x 4.0mm .079" x .157" | 2.0mm x 6.0mm .079" x .236" | 2.0mm x 7.0mm .079" x .275" | | |
| Rectangle | EC7[†] | E2N | E08 | E24 | E2L | Rectangle |
| |  |  |  |  |  | |
| | 2.0mm x 7.5mm .079" x .295" | 2.0mm x 8.0mm .079" x .315" | 2.0mm x 10.0mm .079" x .394" | 2.0mm x 12.7mm .079" x .500" | 2.0mm x 15.3mm .079" x .602" | |
| | ED3 | EN8 | EG7[†] | E58 | EH4[†] | |
| |  |  |  |  |  | |
| 2.0mm x 17.5mm .079" x .689" | 2.0mm x 18.0mm .079" x .710" | 2.0mm x 19.0mm .079" x .750" | 2.0mm x 21.0mm .079" x .827" | 2.0mm x 22.0mm .079" x .866" | | |
| Rectangle | E09[†] | E07[†] | | E30[†] | | Rectangle |
| |  |  | |  | | |
| | 2.0mm x 28.6mm .079" x 1.125" | 2.0mm x 41.3mm .079" x 1.625" | | 2.0mm x 60.0mm .079" x 2.362" | | |
| | E2D | E2F | ER6 | EU5 | E18 | |
| |  |  |  |  |  | |
| 2.3mm x 19.05mm .091" x .750" | 2.3mm x 21.84mm .091" x .860" | 2.5mm x 9.5mm .098" x .374" | 3.0mm x 2.0mm .118" x .079" | 3.0mm x 3.0mm .118" x .118" | | |
| Rectangle | E01 | EM8[†] | ES5 | EW8 | E1Q | Rectangle |
| |  |  |  |  |  | |
| | 3.0mm x 4.0mm .118" x .157" | 3.0mm x 5.0mm .118" x .197" | 3.0mm x 7.0mm .118" x .275" | 3.0mm x 9.0mm .118" x .354" | 3.0mm x 10.0mm .118" x .394" | |

[†] Contact your sales or customer service representative for details, special minimum order quantity may apply.

| | | | | | | |
|-----------|--|---|--|---|---|-----------|
| Rectangle | ES6 | E2H | E44[†] | EC6[†] | | Rectangle |
| |  0.3mm x 16.0mm .118" x .630" |  3.0mm x 19.05mm .118" x .750" |  3.0mm x 25.4mm .118" x 1.000" |  3.0mm x 40.9mm .118" x 1.610" | | |
| Rectangle | ED5[†] | | E70 | EQ1 | E62 | Rectangle |
| |  3.0mm x 43.0mm .118" x 1.693" | |  3.2mm x 6.4mm .125" x .250" |  3.2mm x 9.5mm .125" x .375" |  3.2mm x 9.5mm .125" x .375" | |
| Rectangle | E28 | EM7[†] | EN9[†] | EM9[†] | E74 | Rectangle |
| |  3.2mm x 12.7mm .125" x .500" |  3.2mm x 17.5mm .125" x .689" |  3.2mm x 19.0mm .125" x .750" |  3.2mm x 20.2mm .125" x .794" |  3.3mm x 4.8mm .130" x .190" | |
| Rectangle | E2G | E2J | E1J | E2B | E3E | Rectangle |
| |  3.4mm x 19.05mm .134" x .750" |  3.4mm x 21.84mm .134" x .860" |  3.5mm x 3.5mm .138" x .138" |  3.5mm x 5.0mm .138" x .197" |  3.5mm x 7.0mm .138" x .276" | |
| Rectangle | E65 | EB4 | EW2 | EP6 | EN1[†] | Rectangle |
| |  3.7mm x 21.0mm .146" x .827" |  4.0mm x 4.0mm .157" x .157" |  4.0mm x 6.0mm .157" x .236" |  4.0mm x 8.0mm .157" x .315" |  4.0mm x 10.0mm .157" x .394" | |
| Rectangle | E78 | E47[†] | | EN2 | E73 | Rectangle |
| |  4.0mm x 15.0mm .157" x .591" |  4.6mm x 41.3mm .180" x 1.625" | |  5.0mm x 5.5mm .197" x .217" |  5.0mm x 8.0mm .197" x .315" | |
| Rectangle | EJ7 | ER7 | ES7 | EP2 | E2K | Rectangle |
| |  5.0mm x 9.0mm .197" x .354" |  5.0mm x 10.0mm .197" x .394" |  5.0mm x 12.0mm .197" x .472" |  5.0mm x 14.5mm .197" x .571" |  5.0mm x 21.84mm .197" x .860" | |

† Contact your sales or customer service representative for details, special minimum order quantity may apply.

| | | | | | | |
|-----------|---|--|---|---|---|-----------|
| Rectangle | E14 | EP8 | EN3 | E79 | EN4 | Rectangle |
| |  5.1mm x 5.1mm .200" x .200" |  5.1mm x 6.4mm .200" x .250" |  5.5mm x 10.0mm .217" x .394" |  6.0mm x 6.0mm .236" x .236" |  6.0mm x 6.5mm .236" x .256" | |
| Rectangle | EJ4 | ES8 | ES9 | ET1 | E3A | Rectangle |
| |  6.0mm x 8.0mm .236" x .315" |  6.0mm x 25.4mm .236" x 1.000" |  6.2mm x 22.0mm .244" x .866" |  6.2mm x 28.5mm .244" x 1.122" |  6.35mm x 6.35mm .250" x .250" | |
| Rectangle | E66 | E25 | EG9[†] | | EN5 | Rectangle |
| |  6.4mm x 9.5mm .250" x .375" |  6.4mm x 12.7mm .250" x .500" |  6.4mm x 41.3mm .250" x 1.625" | |  6.5mm x 10.0mm .256" x .394" | |
| Rectangle | EP3 | EP9[†] | E05[†] | EG8 | E63 | Rectangle |
| |  6.5mm x 14.5mm .256" x .571" |  7.0mm x 7.0mm .275" x .275" |  7.5mm x 15.0mm .295" x .591" |  8.0mm x 8.0mm .315" x .315" |  9.5mm x 9.5mm .375" x .375" | |
| Rectangle | E68 | E84[†] | E20[†] | EP5 | E80 | Rectangle |
| |  9.5mm x 12.7mm .375" x .500" |  9.5mm x 20.0mm .375" x .787" |  9.5mm x 25.4mm .375" x 1.000" |  10.0mm x 10.0mm .394" x .394" |  11.5mm x 10.5mm .453" x .414" | |
| Rectangle | EW7 | E75[†] | | E49[†] | E36[†] | Rectangle |
| |  12.7mm x 12.7mm .500" x .500" |  15.9mm x 25.4mm .625" x 1.000" | |  17.0mm x 17.0mm .669" x .669" |  25.0mm x 20.0mm .984" x .787" | |
| P-Shape | E60 | EA7[†] | EQ4 | E52[†] | EX8 | Wedge |
| |  3.3mm x 13.2mm .130" x .402" |  11.4mm x 16.0mm .448" x .630" |  11.4mm x 16.0mm .448" x .630" |  4.0mm x 8.2mm .157" x .324" |  7.6mm x 17.8mm .299" x .701" | |



































† Contact your sales or customer service representative for details, special minimum order quantity may apply.

Profiles

Profiles

| | | | | | | |
|------------|--|---|---|---|--|---------------|
| Wedge | UC301612 [†] | | ER1 | E96 | E67 | Knife-Edge |
| |  11.1mm x 33.3mm .436" x 1.313" | |  1.0mm x 7.0mm .039" x .276" |  2.7mm x 8.0mm .106" x .315" |  2.7mm x 11.3mm .106" x .445" | |
| Knife-Edge | EH6 [†] | E31 | EV9 | E1P | ER2 | Self-Mounting |
| |  2.7mm x 11.3mm .106" x .445" |  2.7mm x 11.3mm .106" x .445" |  2.7mm x 17.5mm .106" x .689" |  3.0mm x 16.5mm .118" x .650" |  5.5mm x 10.0mm .217" x .394" | |
| | E19 [†] | E93 [†] | EB9 | E27 [†] | E86 [†] | |
| |  6.4mm x 19.1mm .250" x .750" |  2.5mm x 8.4mm .100" x .330" |  3.7mm x 6.5mm .145" x .256" |  16.2mm x 5.8mm .638" x .230" |  18.8mm x 9.7mm .740" x .380" | |
| | Mini-Clip | | | | | |
| Bell-shape | E1H | EU7 | E3F | ET2 | E1R | Bell-shape |
| |  1.8mm x 4.6mm .071" x .181" |  2.5mm x 7.6mm .098" x .300" |  2.54mm x 10.0mm .100" x .394" |  3.0mm x 8.0mm .118" x .315" |  3.0mm x 10.1mm .118" x .398" | |
| | E1U | E3G | E3H | E1T | ER8 | |
| L-Shape |  3.0mm x 15.0mm .118" x .591" |  3.05mm x 10.2mm .120" x .402" |  3.6mm x 12.7mm .142" x .500" |  4.0mm x 15.0mm .157" x .591" |  5.5mm x 15.0mm .217" x .591" | |
| | E1C [†] | ED2 [†] | E13 [†] | EW1 | E1V | D-Shape |
| |  3.3mm x 5.3mm .130" x .209" |  5.0mm x 8.5mm .197" x .335" |  5.5mm x 12.0mm .217" x .472" |  1.0mm x 3.8mm .039" x .150" |  1.2mm x 10.0mm .047" x .394" | |
| E1W | E17 | EY3 | ET6 | EY4 | | |
| |  1.3mm x 3.6mm .051" x .142" |  1.5mm x 3.8mm .060" x .150" |  1.5mm x 6.0mm .059" x .236" |  1.5mm x 6.4mm .059" x .250" |  1.5mm x 8.0mm .059" x .315" | |



































[†] Contact your sales or customer service representative for details, special minimum order quantity may apply.

| | | | | | | |
|--|--|---|--|--|--|---------|
| D-Shape | EY5 | EY2 | EY6 | EG6 [†] | E1F | D-Shape |
| |  1.5mm x 10.0mm .059" x .394" |  1.5mm x 12.7mm .059" x .500" |  1.5mm x 17.0mm .059" x .669" |  1.8mm x 4.6mm .070" x .180" |  1.8mm x 4.6mm .071" x .181" | |
| D-Shape | E1Y | EK9 | ES3 | EV3 | EJ8 | D-Shape |
| |  2.0mm x 4.0mm .079" x .157" |  2.0mm x 6.0mm .078" x .236" |  2.0mm x 6.0mm .079" x .236" |  2.0mm x 8.0mm .079" x .315" |  2.0mm x 10.0mm .079" x .394" | |
| | EK4 | EY7 | E51 | EH2 | EP1 | |
| |  2.0mm x 12.7mm .079" x .500" |  2.0mm x 17.0mm .079" x .669" |  2.0mm x 17.1mm .080" x .675" |  2.0mm x 17.2mm .080" x .675" |  2.3mm x 8.0mm .090" x .315" | |
| | E57 | E45 | EQ6 | EJ9 | EK5 | |
|  2.3mm x 2.3mm .090" x .090" |  2.3mm x 3.9mm .090" x .155" |  2.3mm x 6.0mm .090" x .236" |  2.3mm x 10.0mm .090" x .394" |  2.3mm x 12.7mm .090" x .500" | | |
| ED7 | EV8 | ES4 | ET9 | EX6 | | |
|  2.3mm x 12.7mm .090" x .500" |  2.3mm x 17.1mm .091" x .673" |  2.5mm x 6.4mm .100" x .250" |  2.5mm x 7.6mm .100" x .300" |  2.5mm x 10.0mm .100" x .394" | | |
| EY1 | EQ7 | EU8 | EK1 | EK6 | | |
|  2.7mm x 2.9mm .106" x .114" |  2.7mm x 6.0mm .106" x .236" |  2.7mm x 8.0mm .106" x .315" |  2.7mm x 10.0mm .106" x .394" |  2.7mm x 12.7mm .106" x .500" | | |
| EY8 | E87 | E2S | E2M | E2T | | |
|  2.7mm x 17.0mm .106" x .669" |  2.8mm x 9.7mm .110" x .380" |  3.0mm x 6.0mm .118" x .236" |  3.0mm x 8.0mm .118" x .315" |  3.0mm x 8.0mm .118" x .315" | | |















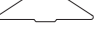



















[†] Contact your sales or customer service representative for details, special minimum order quantity may apply.

Profiles



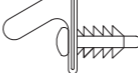







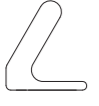

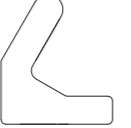
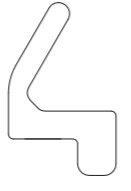

Profiles

| | | | | | | |
|---------|---|---|---|---|---|---------|
| D-Shape | E2P | ER9 | E2U | E2V | EA3 | D-Shape |
| |  |  |  |  |  | |
| | 3.0mm x 10.0mm .118" x .394" | 3.0mm x 12.7mm .118" x .500" | 3.0mm x 12.7mm .118" x .500" | 3.0mm x 17.0mm .118" x .669" | 3.1mm x 3.8mm .120" x .150" | |
| D-Shape | EA1 | E26 | EX7 | EJ5 | EV1 | D-Shape |
| |  |  |  |  |  | |
| | 3.1mm x 6.4mm .120" x .250" | 3.1mm x 9.1mm .120" x .360" | 3.1mm x 12.7mm .122" x .500" | 3.18mm x 12.7mm .125" x .500" | 3.3mm x 4.8mm .130" x .189" | |
| D-Shape | EQ8 | EV6 | EK2 | EK7 | EY9 | D-Shape |
| |  |  |  |  |  | |
| | 3.3mm x 6.0mm .130" x .236" | 3.3mm x 8.0mm .130" x .315" | 3.3mm x 10.0mm .130" x .394" | 3.3mm x 12.7mm .130" x .500" | 3.3mm x 17.0mm .130" x .669" | |
| D-Shape | E2W | E2X | EM6 | E2R | E2Y | D-Shape |
| |  |  |  |  |  | |
| | 3.5mm x 6.0mm .138" x .236" | 3.5mm x 8.0mm .138" x .315" | 3.5mm x 9.5mm .140" x .375" | 3.5mm x 10.0mm .138" x .394" | 3.5mm x 12.7mm .138" x .500" | |
| D-Shape | E3B | E90 | EG4 | EQ9 | EV7 | D-Shape |
| |  |  |  |  |  | |
| | 3.5mm x 17.0mm .138" x .669" | 3.6mm x 6.4mm .140" x .250" | 3.8mm x 3.8mm .150" x .150" | 3.8mm x 6.0mm .149" x .236" | 3.8mm x 8.0mm .150" x .315" | |
| D-Shape | EK3 | EK8 | E1A | EA5 | E35 | D-Shape |
| |  |  |  |  |  | |
| | 3.8mm x 10.0mm .150" x .394" | 3.8mm x 12.7mm .150" x .500" | 3.8mm x 17.0mm .149" x .669" | 4.0mm x 6.0mm .156" x .236" | 4.0mm x 7.4mm .156" x .292" | |
| D-Shape | E43[†] | E1D | EH1 | EH7 | E3C | D-Shape |
| |  |  |  |  |  | |
| | 4.0mm x 7.4mm .156" x .292" | 4.0mm x 11.0mm .157" x .433" | 4.0mm x 12.7mm .157" x .500" | 4.0mm x 12.7mm .157" x .500" | 4.06mm x 14.22mm .160" x .560" | |

† Contact your sales or customer service representative for details, special minimum order quantity may apply.

| | | | | | | |
|---------|---|---|---|---|---|---------|
| D-Shape | EX5 | E1E | E2A | EM5 | EM3[†] | D-Shape |
| |  |  |  |  |  | |
| | 4.1mm x 14.2mm .161" x .559" | 4.1mm x 18.3mm .161" x .720" | 4.3mm x 6.4mm .169" x .252" | 4.3mm x 9.7mm .170" x .380" | 4.3mm x 12.7mm .169" x .500" | |
| D-Shape | E1N | EV2 | E64[†] | EB1[†] | E04 | D-Shape |
| |  |  |  |  |  | |
| | 4.5mm x 10.0mm .177" x .394" | 4.6mm x 10.2mm .181" x .402" | 4.7mm x 12.2mm .185" x .480" | 4.7mm x 12.2mm .185" x .480" | 4.8mm x 7.6mm .189" x .300" | |
| D-Shape | EC9 | EM2[†] | ER4 | E3D | EJ1 | D-Shape |
| |  |  |  |  |  | |
| | 5.0mm x 17.2mm .197" x .675" | 5.0mm x 17.2mm .197" x .675" | 5.08mm x 6.35mm .200" x .250" | 5.25mm x 17.15mm .207" x .675" | 5.5mm x 12.7mm .217" x .500" | |
| D-Shape | EW3 | E1G | EU9 | E10 | ER5 | D-Shape |
| |  |  |  |  |  | |
| | 5.8mm x 12.7mm .228" x .500" | 6.0mm x 17.0mm .236" x .669" | 6.4mm x 6.4mm .252" x .252" | 6.4mm x 9.5mm .250" x .375" | 7.6mm x 6.9mm .299" x .272" | |
| D-Shape | EP4 | EH5 | EX4 | E56[†] | E21 | C-Fold |
| |  |  |  |  |  | |
| | 8.5mm x 10.0mm .335" x .394" | 9.53mm x 12.7mm .375" x .500" | 12.7mm x 12.7mm .500" x .500" | 6.1mm x 7.4mm .240" x .292" | 6.4mm x 5.9mm .250" x .234" | |
| C-Fold | EC3 | EH3 | EG3[†] | EM4[†] | E98 | C-Fold |
| |  |  |  |  |  | |
| | 6.4mm x 7.1mm .250" x .280" | 8.0mm x 8.0mm .315" x .315" | 9.8mm x 10.7mm .385" x .420" | 9.8mm x 10.7mm .385" x .420" | 9.8mm x 10.7mm .385" x .420" | |
| C-Fold | E98 Riveted[†] | EH9[†] | E55[†] | E40 | ED8[†] | C-Fold |
| |  |  |  |  |  | |
| | 9.8mm x 10.7mm .385" x .420" | 9.8mm x 10.7mm .385" x .420" | 9.8mm x 12.2mm .385" x .480" | 10.0mm x 10.9mm .395" x .430" | 11.4mm x 16.0mm .448" x .630" | |

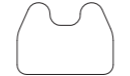
† Contact your sales or customer service representative for details, special minimum order quantity may apply.

| | | | | | | |
|-------------|---|---|---|---|---|-------------|
| C-Fold | EQ3 | E85 | E32 | E16 [†] | E02 [†] | C-Fold |
| |  |  |  |  |  | |
| | 11.8mm x 10.7mm .465" x .420" | 11.8mm x 10.7mm .465" x .420" | 17.1mm x 14.7mm .675" x .580" | 18.0mm x 14.2mm .710" x .560" | 23.9mm x 14.0mm .940" x .550" | |
| T-Shape | ED4 [†] | ED1 [†] | EA9 | EJ2 | E41 [†] | T-Shape |
| |  |  |  |  |  | |
| | 3.9mm x 6.0mm .152" x .235" | 4.0mm x 6.2mm .157" x .244" | 4.0mm x 6.2mm .157" x .244" | 4.0mm x 6.2mm .157" x .244" | 5.1mm x 4.8mm .200" x .190" | |
| U-Shape | EQ2 [†] | E53 [†] | EH8 [†] | EG5 | | U-Shape |
| |  |  |  |  | | |
| | 6.4mm x 4.8mm .250" x .190" | 7.6mm x 6.9mm .300" x .272" | 10.0mm x 10.0mm .395" x .395" | 9.5mm x 12.7mm .374" x .500" | | |
| Round Shape | E3J | | E3K | | | Round Shape |
| |  | |  | | | |
| | 3.0mm diameter .118" diameter | | 4.0mm diameter .157" diameter | | | |

Standard Pressure – Sensitive Adhesive (PSA)

SEM gaskets come with adhesive that is made to order. This chart contains the standard PSA widths used on gaskets in the Profile Selection Guide. Other PSA widths may be requested. The Wide Release Liner™ tape option is also available for many profiles for “pick-n-place” assembly. For information on PSA options, please contact your SEM representative.

Self-Mounting gaskets are designed to be applied without adhesives. Adhesive mounting is an option on these profiles.

For I/O information, please call your SEM representative.

| Part | PSA WIDTH | | | | Part | PSA WIDTH | | | |
|------------------|--------------|-------------|-------------|--|------------------|--------------|-------------|-------------|--|
| | Inches | mm | Inches [mm] | | | Inches | mm | Inches [mm] | |
| Rectangle | | | | | Rectangle | | | | |
| E01 | .118 x .157 | 3.0 x 4.0 | .070 [1.8] | | EC5 | .039 x 1.627 | 1.0 x 41.3 | .250 [6.4] | |
| E03 | .039 x .157 | 1.0 x 4.0 | .070 [1.8] | | EC6 | .118 x 1.610 | 3.0 x 40.9 | .100 [2.5] | |
| E05 | .295 x .591 | 7.5 x 15.0 | .250 [6.4] | | EC7 | .079 x .295 | 2.0 x 7.5 | .125 [3.2] | |
| E06 | .039 x .276 | 1.0 x 7.0 | .125 [3.2] | | ED3 | .079 x .689 | 2.0 x 17.5 | .188 [4.8] | |
| E07 | .079 x 1.625 | 2.0 x 41.3 | .125 [3.2] | | ED5 | .118 x 1.693 | 3.0 x 43.0 | .070 [1.8] | |
| E08 | .079 x .394 | 2.0 x 10.0 | .125 [3.2] | | ED9 | .059 x .197 | 1.5 x 5.0 | .100 [2.5] | |
| E09 | .079 x 1.125 | 2.0 x 28.6 | .125 [3.2] | | EG2 | .059 x .390 | 1.5 x 10.0 | .125 [3.2] | |
| E11 | .039 x .394 | 1.0 x 10.0 | .125 [3.2] | | EG7 | .079 x .750 | 2.0 x 19.0 | .125 [3.2] | |
| E12 | .039 x .197 | 1.0 x 5.0 | .100 [2.5] | | EG8 | .315 x .315 | 8.0 x 8.0 | .125 [3.2] | |
| E14 | .200 x .200 | 5.1 x 5.1 | .100 [2.5] | | EG9 | .250 x 1.625 | 6.4 x 41.3 | .125 [3.2] | |
| E18 | .118 x .118 | 3.0 x 3.0 | .070 [1.8] | | EH4 | .079 x .866 | 2.0 x 22.0 | .250 [6.4] | |
| E20 | .375 x 1.000 | 9.5 x 25.4 | .500 [12.7] | | EJ4 | .236 x .315 | 6.0 x 8.0 | .125 [3.2] | |
| E24 | .079 x .500 | 2.0 x 12.7 | .250 [6.4] | | EJ6 | .039 x .591 | 1.0 x 15.0 | .250 [6.4] | |
| E25 | .250 x .500 | 6.4 x 12.7 | .250 [6.4] | | EJ7 | .197 x .354 | 5.0 x 9.0 | .125 [3.2] | |
| E28 | .125 x .500 | 3.2 x 12.7 | .250 [6.4] | | EM7 | .125 x .689 | 3.2 x 17.5 | .125 [3.2] | |
| E29 | .039 x 1.000 | 1.0 x 25.4 | .250 [6.4] | | EM8 | .118 x .197 | 3.0 x 5.0 | .100 [2.5] | |
| E30 | .079 x 2.362 | 2.0 x 60.0 | .125 [3.2] | | EM9 | .125 x .794 | 3.2 x 20.2 | .100 [2.5] | |
| E36 | .984 x .787 | 25.0 x 20.0 | .313 [8.0] | | EN1 | .157 x .394 | 4.0 x 10.0 | .188 [4.8] | |
| E37 | .039 x .118 | 1.0 x 3.0 | .070 [1.8] | | EN2 | .197 x .217 | 5.0 x 5.5 | .100 [2.5] | |
| E39 | .390 x .710 | 1.0 x 18.0 | .125 [3.2] | | EN3 | .217 x .394 | 5.5 x 10.0 | .125 [3.2] | |
| E44 | .118 x 1.000 | 3.0 x 25.4 | .500 [12.8] | | EN4 | .236 x .256 | 6.0 x 6.5 | .125 [3.2] | |
| E47 | .180 x 1.625 | 4.6 x 41.3 | .250 [6.4] | | EN5 | .256 x .394 | 6.5 x 10.0 | .125 [3.2] | |
| E49 | .669 x .669 | 17.0 x 17.0 | .312 [7.9] | | EN6 | .059 x .150 | 1.5 x 3.8 | .100 [2.5] | |
| E58 | .079 x .827 | 2.0 x 21.0 | .125 [3.2] | | EN8 | .079 x .710 | 2.0 x 18.0 | .070 [1.8] | |
| E59 | .020 x .197 | 0.5 x 5.0 | .100 [2.5] | | EN9 | .125 x .750 | 3.2 x 19.0 | .100 [2.5] | |
| E61 | .059 x .275 | 1.5 x 7.0 | .125 [3.2] | | EP2 | .197 x .571 | 5.0 x 14.5 | .250 [6.4] | |
| E62 | .125 x .375 | 3.2 x 9.5 | .188 [4.8] | | EP3 | .256 x .571 | 6.5 x 14.5 | .250 [6.4] | |
| E63 | .375 x .375 | 9.5 x 9.5 | .188 [4.8] | | EP5 | .394 x .394 | 10.0 x 10.0 | .250 [6.4] | |
| E65 | .146 x .827 | 3.7 x 21.0 | .125 [3.2] | | EP6 | .157 x .315 | 4.0 x 8.0 | .125 [3.2] | |
| E66 | .250 x .375 | 6.4 x 9.5 | .188 [4.8] | | EP8 | .200 x .250 | 5.1 x 6.4 | .125 [3.2] | |
| E68 | .375 x .500 | 9.5 x 12.7 | .250 [6.4] | | EP9 | .275 x .275 | 7.0 x 7.0 | .125 [3.2] | |
| E70 | .125 x .250 | 3.2 x 6.4 | .125 [3.2] | | EQ1 | .125 x .375 | 3.2 x 9.5 | .188 [4.8] | |
| E73 | .197 x .315 | 5.0 x 8.0 | .125 [3.2] | | ER3 | .059 x .125 | 1.5 x 3.18 | .070 [1.8] | |
| E74 | .130 x .190 | 3.3 x 4.8 | .100 [2.5] | | ER6 | .098 x .374 | 2.5 x 9.5 | .188 [4.8] | |
| E75 | .625 x 1.000 | 15.9 x 25.4 | .250 [6.4] | | ER7 | .197 x .394 | 5.0 x 10.0 | .188 [4.8] | |
| E77 | .079 x .275 | 2.0 x 7.0 | .125 [3.2] | | ES1 | .020 x .236 | 0.5 x 6.0 | .100 [2.5] | |
| E78 | .157 x .591 | 4.0 x 15.0 | .250 [6.4] | | ES2 | .020 x .669 | 0.5 x 17.0 | .100 [3.2] | |
| E79 | .236 x .236 | 6.0 x 6.0 | .125 [3.2] | | ES5 | .118 x .275 | 3.0 x 7.0 | .125 [3.2] | |
| E80 | .453 x .414 | 11.5 x 10.5 | .188 [4.8] | | ES6 | .118 x .630 | 3.0 x 16.0 | .125 [2.5] | |
| E81 | .079 x .157 | 2.0 x 4.0 | .070 [1.8] | | ES7 | .197 x .472 | 5.0 x 12.0 | .250 [6.4] | |
| E83 | .020 x .157 | 0.5 x 4.0 | .070 [1.8] | | ES8 | .236 x 1.000 | 6.0 x 25.4 | .500 [12.7] | |
| E84 | .375 x .787 | 9.5 x 20.0 | .250 [6.4] | | ES9 | .244 x .866 | 6.2 x 22.0 | .500 [12.7] | |
| E88 | .020 x .276 | 0.5 x 7.0 | .125 [3.2] | | ET1 | .244 x 1.122 | 6.2 x 28.5 | .500 [12.7] | |
| E91 | .020 x .394 | 0.5 x 10.0 | .125 [3.2] | | ET3 | .039 x .433 | 1.0 x 11.0 | .250 [6.4] | |
| E97 | .049 x .315 | 1.2 x 8.0 | .070 [1.8] | | ET4 | .039 x .535 | 1.0 x 13.6 | .250 [6.4] | |
| E99 | .039 x .512 | 1.0 x 13.0 | .250 [6.4] | | ET5 | .039 x .630 | 1.0 x 16.0 | .100 [2.5] | |
| EA8 | .059 x 1.063 | 1.5 x 27.0 | .125 [3.2] | | ET7 | .059 x .638 | 1.5 x 16.2 | .100 [2.5] | |
| EB4 | .157 x .157 | 4.0 x 4.0 | .070 [1.8] | | ET8 | .020 x .886 | 0.5 x 22.5 | .250 [6.4] | |
| EB5 | .059 x .551 | 1.5 x 14.0 | .250 [6.4] | | EU1 | .020 x .591 | 0.5 x 15.0 | .070 [1.8] | |

Drawings are representative of the profile. Please contact your SEM representative for engineering drawings.



† Contact your sales or customer service representative for details, special minimum order quantity may apply.

Schlegel Electronic Materials (SEM) introduces **DynaShear** and **DynaGreen™** an innovative EMI shielding gasket family for the shielding of modules in card/cages environment that is able to offer superior features over metal fingerstocks and current Fabric Over Foam gaskets. **DynaShear** and **DynaGreen™** utilize the bump technology that result from a three axis development program:

- SEM famous special flat D-Profiles with bump
- Low memory ultra soft foam type 7
- Abrasion resistant conductive fabrics

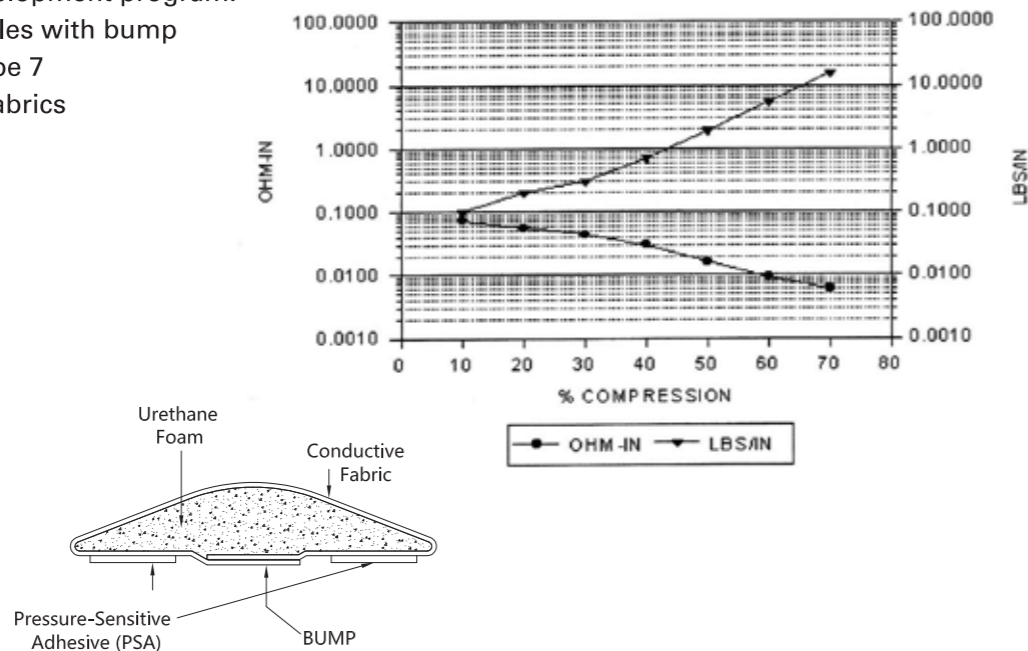

Both programs **DynaShear** and **DynaGreen™** are supplied with a flammability UL94-V0 rating but **DynaGreen™** utilizes a special SEM's formulation for the retardants making that series **Halogen Free** according to IEC 61249-2-21 (900 ppm max. bromine, 900 ppm max chlorine max. with a total of max. 1500 ppm). **DynaGreen™** is supplied with a special blue liner with a clear printed identification.

| Height Width | 1.5mm | 2.0mm | 2.3mm | 2.7mm | 3.0mm | 3.3mm | 3.5mm | 3.8mm |
|-----------------|-----------------|-----------------|-----------------|-----------------|-----------------|-----------------|-----------------|-----------------|
| 6mm | EY37n2Zxxxx(HF) | EK97n2Zxxxx(HF) | EQ67n2Zxxxx(HF) | EQ77n2Zxxxx(HF) | E2S7n2Zxxxx(HF) | EQ87n2Zxxxx(HF) | E2W7n2Zxxxx(HF) | EQ97n2Zxxxx(HF) |
| 8mm | EY47n2Zxxxx(HF) | EV37n2Zxxxx(HF) | EP17n2Zxxxx(HF) | EU87n2Zxxxx(HF) | E2T7n2Zxxxx(HF) | EV67n2Zxxxx(HF) | E2X7n2Zxxxx(HF) | EV77n2Zxxxx(HF) |
| 10mm | EY57n2Zxxxx(HF) | EJ87n2Zxxxx(HF) | EJ97n2Zxxxx(HF) | EK17n2Zxxxx(HF) | E2P7n2Zxxxx(HF) | EK27n2Zxxxx(HF) | E2R7n2Zxxxx(HF) | EK37n2Zxxxx(HF) |
| 12.7mm | EY27n2Zxxxx(HF) | EK47n2Zxxxx(HF) | EK57n2Zxxxx(HF) | EK67n2Zxxxx(HF) | E2U7n2Zxxxx(HF) | EK77n2Zxxxx(HF) | E2Y7n2Zxxxx(HF) | EK87n2Zxxxx(HF) |
| 17mm | EY67n2Zxxxx(HF) | EY77n2Zxxxx(HF) | EV87n2Zxxxx(HF) | EY87n2Zxxxx(HF) | E2V7n2Zxxxx(HF) | EY97n2Zxxxx(HF) | E3B7n2Zxxxx(HF) | E1A7n2Zxxxx(HF) |

n: specifies the fabric type (3: NiCu-C70 and 4: NiCu-C12).
xxxx: specifies the length in the form of xx.xx".
HF: specifies Halogen Free. **DynaGreen™** has suffix "HF".
 Standard parts supplied with wide release liner and 2 strips of adhesive.
 Height given for untapped and uncompressed parts.

DynaShear / DynaGreen™: Technical Features

- Compression force:** 0.70 lbs.-inch at 40% compression (*)
- Contact resistance:** 0.012 Ohms-inch at 40% compression (*)
- Compression set:** 15.4% when compressed 50% for 22 hrs. at 70°C (*)
- Recommended compression for max. shielding:** See table in the "gasket selection" section.
- Abrasion resistance:** No change in surface resistivity 800,000 cycles (NiCu-C70)
- General Service Temperature:** -40°C (-40°F), 70°C (158°F)
- Flammability:** UL94-V0 certified (under the component program of Underwriters Laboratories Inc. in specified claddings and thicknesses)
- Shielding Effectiveness:** 96 dB (average) 20 MHz-10 GHz - Mil DTL 83528 C (NiCu-C70)
- 3M Adhesive 90° peel strength on stainless steel:** 128/142 Oz./in after 72 hours -ASTM D3330

(*): measured on EJ9732ZXXXX

DynaShear / DynaGreen™: Gasket selection

These series of D-shape gaskets are characterized by the presence of a bump at the bottom surface so to preserve a substantial shielding effectiveness even when compression is low. RF measurement shows that below 20% and down to almost 0% compression, Shielding Effectiveness is about the value measured at 20% compression. The thickness of the bump is typically 0.3 mm. The specific adhesive used on this series has been selected for its high shear strength and has a nominal thickness of 0.17 mm.

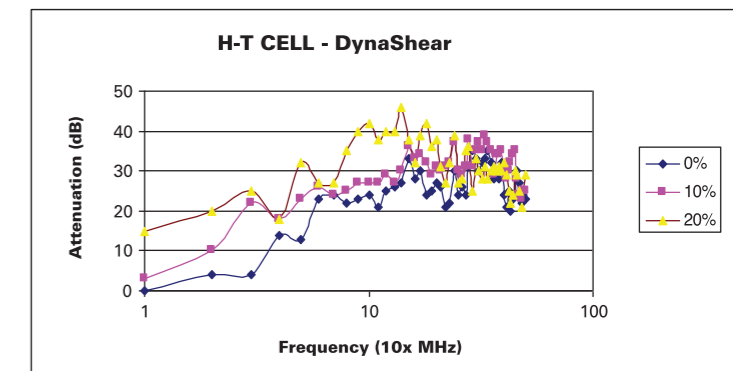

Attenuation as a function of the compression measured on EJ9732ZXXXX.

The dimensions provided in this catalog are the dimensions for the parts un-taped and in an uncompressed state. When the part is taped, the bump is slightly compressed. Therefore, the following values and table are provided to help the selection of the right profile versus the nominal gap between modules. The compression values for the gasket (% from free height) are given in black and the corresponding values of the gap between modules are provided in blue (in mm).

- Minimum Compression (mC):** mC = 1%
- Maximum Gap (MG):** MG (mm) = 0.99 * h with h (mm) = [(H - 0.3) + 0.17].
- Nominal Compression (NC):** SEM recommend to compress 50% of the free height h
NC (%) = 50
- Nominal Gap (NG):**
NG (mm) = h * 0.5
- Max. Compression (MC):**
MC (%) = (h-S)/h* 100 with S(mm)= s + 0.17
- Minimum Gap (mG) :** mG = S

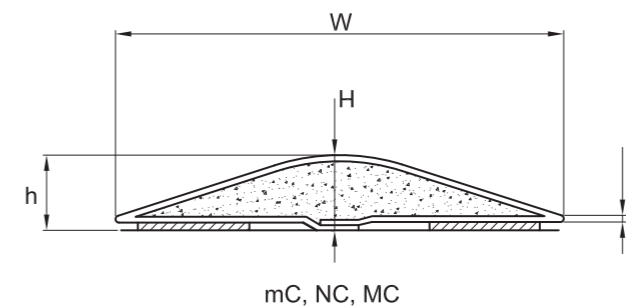

MG, NG, mG

DynaShear / DynaGreen™ Profile Selection Versus Nominal Gap

| P/N | H(mm) | W(mm) | s(mm) | h(mm) | mC(%) | MG(mm) | NC(%) | NG(mm) | MC(%) | mG(mm) |
|-----|-------|-------|-------|-------|-------|--------|-------|--------|-------|--------|
| EY3 | 1.5 | 6.0 | 0.36 | 1.37 | 1 | 1.36 | 50 | 0.69 | 61.31 | 0.53 |
| EY4 | 1.5 | 8.0 | 0.39 | 1.37 | 1 | 1.36 | 50 | 0.69 | 59.12 | 0.56 |
| EY5 | 1.5 | 10.0 | 0.39 | 1.37 | 1 | 1.36 | 50 | 0.69 | 59.12 | 0.56 |
| EY2 | 1.5 | 12.7 | 0.40 | 1.37 | 1 | 1.36 | 50 | 0.69 | 58.39 | 0.57 |
| EY6 | 1.5 | 17.0 | 0.41 | 1.37 | 1 | 1.36 | 50 | 0.69 | 57.66 | 0.58 |
| EK9 | 2.0 | 6.0 | 0.35 | 1.87 | 1 | 1.85 | 50 | 0.94 | 72.19 | 0.52 |
| EV3 | 2.0 | 8.0 | 0.42 | 1.87 | 1 | 1.85 | 50 | 0.94 | 68.45 | 0.59 |
| EJ8 | 2.0 | 10.0 | 0.48 | 1.87 | 1 | 1.85 | 50 | 0.94 | 65.24 | 0.65 |
| EK4 | 2.0 | 12.7 | 0.39 | 1.87 | 1 | 1.85 | 50 | 0.94 | 70.05 | 0.56 |
| EY7 | 2.0 | 17.0 | 0.54 | 1.87 | 1 | 1.85 | 50 | 0.94 | 62.03 | 0.71 |
| EQ6 | 2.3 | 6.0 | 0.36 | 2.17 | 1 | 2.15 | 50 | 1.09 | 75.58 | 0.53 |
| EP1 | 2.3 | 8.0 | 0.39 | 2.17 | 1 | 2.15 | 50 | 1.09 | 74.19 | 0.56 |
| EJ9 | 2.3 | 10.0 | 0.39 | 2.17 | 1 | 2.15 | 50 | 1.09 | 74.19 | 0.56 |
| EK5 | 2.3 | 12.7 | 0.60 | 2.17 | 1 | 2.15 | 50 | 1.09 | 64.52 | 0.77 |
| EV8 | 2.3 | 17.0 | 0.75 | 2.17 | 1 | 2.15 | 50 | 1.09 | 57.60 | 0.92 |
| EQ7 | 2.7 | 6.0 | 0.36 | 2.57 | 1 | 2.54 | 50 | 1.29 | 79.38 | 0.53 |
| EU8 | 2.7 | 8.0 | 0.37 | 2.57 | 1 | 2.54 | 50 | 1.29 | 78.99 | 0.54 |
| EK1 | 2.7 | 10.0 | 0.39 | 2.57 | 1 | 2.54 | 50 | 1.29 | 78.21 | 0.56 |
| EK6 | 2.7 | 12.7 | 0.57 | 2.57 | 1 | 2.54 | 50 | 1.29 | 71.21 | 0.74 |
| EY8 | 2.7 | 17.0 | 0.80 | 2.57 | 1 | 2.54 | 50 | 1.29 | 62.26 | 0.97 |
| E2S | 3.0 | 6.0 | 0.34 | 2.87 | 1 | 2.84 | 50 | 1.44 | 82.23 | 0.51 |
| E2T | 3.0 | 8.0 | 0.37 | 2.87 | 1 | 2.84 | 50 | 1.44 | 81.18 | 0.54 |
| E2P | 3.0 | 10.0 | 0.54 | 2.87 | 1 | 2.84 | 50 | 1.44 | 75.26 | 0.71 |
| E2U | 3.0 | 12.7 | 0.58 | 2.87 | 1 | 2.84 | 50 | 1.44 | 73.87 | 0.75 |
| E2V | 3.0 | 17.0 | 0.79 | 2.87 | 1 | 2.84 | 50 | 1.44 | 66.55 | 0.96 |
| EQ8 | 3.3 | 6.0 | 0.34 | 3.17 | 1 | 3.14 | 50 | 1.59 | 83.91 | 0.51 |
| EV6 | 3.3 | 8.0 | 0.37 | 3.17 | 1 | 3.14 | 50 | 1.59 | 82.97 | 0.54 |
| EK2 | 3.3 | 10.0 | 0.57 | 3.17 | 1 | 3.14 | 50 | 1.59 | 76.66 | 0.74 |
| EK7 | 3.3 | 12.7 | 0.57 | 3.17 | 1 | 3.14 | 50 | 1.59 | 76.66 | 0.74 |
| EY9 | 3.3 | 17.0 | 0.80 | 3.17 | 1 | 3.14 | 50 | 1.59 | 69.40 | 0.97 |
| E2W | 3.5 | 6.0 | 0.32 | 3.37 | 1 | 3.34 | 50 | 1.69 | 85.46 | 0.49 |
| E2X | 3.5 | 8.0 | 0.35 | 3.37 | 1 | 3.34 | 50 | 1.69 | 84.57 | 0.52 |
| E2R | 3.5 | 10.0 | 0.39 | 3.37 | 1 | 3.34 | 50 | 1.69 | 83.38 | 0.56 |
| E2Y | 3.5 | 12.7 | 0.29 | 3.37 | 1 | 3.34 | 50 | 1.69 | 86.35 | 0.46 |
| E3B | 3.5 | 17.0 | 0.79 | 3.37 | 1 | 3.34 | 50 | 1.69 | 71.51 | 0.96 |
| EQ9 | 3.8 | 6.0 | 0.33 | 3.67 | 1 | 3.63 | 50 | 1.84 | 86.38 | 0.50 |
| EV7 | 3.8 | 8.0 | 0.39 | 3.67 | 1 | 3.63 | 50 | 1.84 | 84.74 | 0.56 |
| EK3 | 3.8 | 10.0 | 0.35 | 3.67 | 1 | 3.63 | 50 | 1.84 | 85.83 | 0.52 |
| EK8 | 3.8 | 12.7 | 0.57 | 3.67 | 1 | 3.63 | 50 | 1.84 | 79.84 | 0.74 |
| E1A | 3.8 | 17.0 | 0.78 | 3.67 | 1 | 3.63 | 50 | 1.84 | 74.11 | 0.95 |

Using the table

1. Pick in the table the nominal gap **NG(mm)** the closest to the actual one in your application.
2. Select the width **W** (mm) in order to fill the gap as much as possible.
3. Verify that **mG** and **MG** values are within the tolerances of the nominal gap **NG**.

Schlegel Electronic Materials (SEM), a well-respected leader in the EMI Shielding industry, introduces Fabric Over Silicone EMI Gaskets (FOS) for high temperature applications. FOS has been developed with a new flame retardant formulation providing EMI shielding gaskets with UL94-V0 grade (Underwriters Laboratories Inc.) and Halogen Free according to IEC 61249-2-21 (<=900 ppm chlorine, <=900 ppm bromine and 1500 ppm max. halogens). Fabric Over Silicone EMI gaskets provide low compression forces, low compression set and an operating temperature that can be up to 125°C (257°F). Combined with Highly flexible SEM fabrics NiCu-C12 or NiCu-C70, Fabric Over Silicone gaskets still feature over 70 dB attenuation at 40 GHz (SEM Stripline method) making this product ideal for on-board shielding or high temperature environment. Fabric Over Silicone is currently available for all the SEM rectangular profiles.



Fig 1. Contact Resistance and Compression Load Deflection Testing result of ED9 (1.5 x 5.0 mm) Gasket

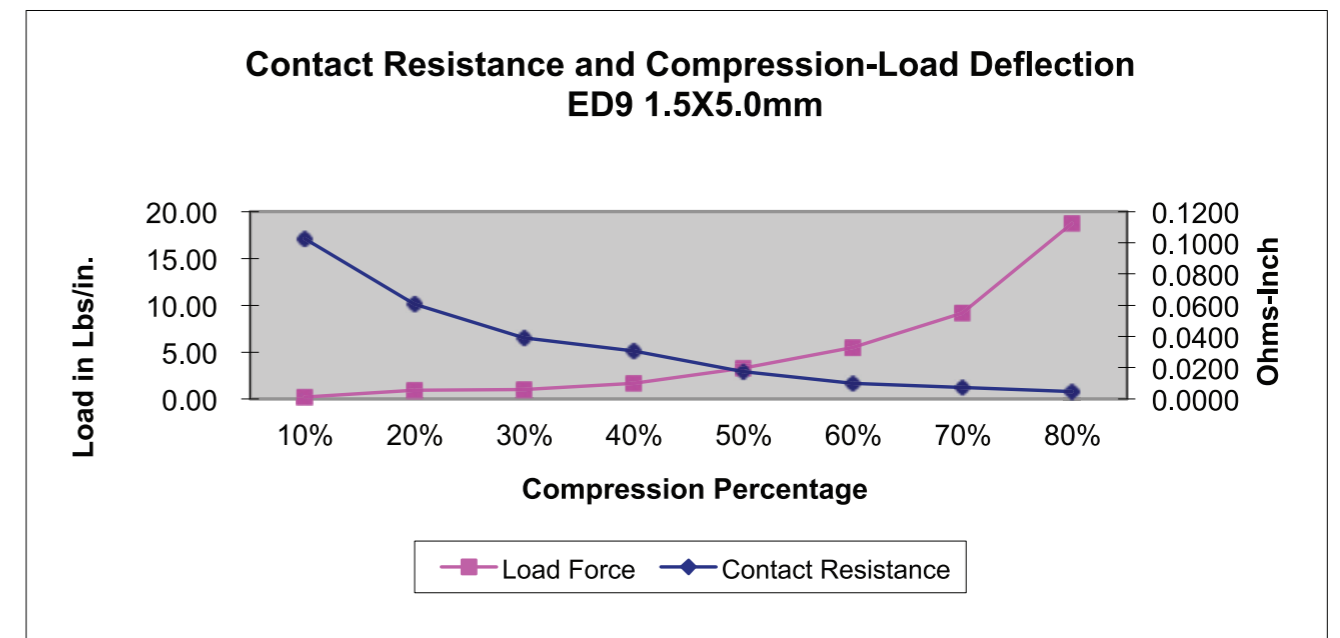

Technical Specifications

| CHARACTERISTICS | SPECIFICATIONS | TEST METHODS |
|--------------------------------|---|---------------------------------------|
| Shielding Effectiveness | 96 dB average (20MHz-10GHz) : NiCu-C70 97.4 dB average (20MHz-10GHz): NiCu-C12 | MIL DTL 83528 C |
| Compression Force | 1.70 lbs/inch @ 40%* | SEM LP-3001 |
| Contact Resistance | 0.031 ohms-inch @ 40%* | SEM LP-3001 |
| Compression Set | 5% (compressed 50% for 22 hrs at 70°C) * * | ASTM D 3574 |
| Compression Range | 30 – 70 % | |
| Surface Resistance | <=0.066 Ohms/sq. : NiCu-C70 <=0.024 Ohms/sq. : NiCu-C12 | ASTM F390 |
| Contact Resistance at 1Kg load | < 0.11 ohms-in < 0.08 ohms-in | SEM LP-3001 |
| Operating Temperature | -40°C , +125°C | ASTM D3574 |
| Abrasion Resistance | >= 800,000 cycles: NiCu-C70 >=1,000,000 cycles: NiCu-C12 | ASTM D3886 |
| Flame Retardant | UL94 V0 | UL94 (Underwriters Laboratories, Inc) |
| Compliance | 2011/65/EU (RoHS 2.0) Compliant REACH SVHC Compliance | |
| Halogen Content | <=900 ppm chlorine & <=900 ppm bromine & 1500 ppm max for both | IEC 61249-2-21 / EN 14852 B |

* Result is measured on the ED9 Resulted measured => Result was measured ED9 (1.5 x 5.0 mm) profiles

**Result measured on the 5 mm x 25.4 mm x 25.4 mm silicone foam

The technical specification data is based on SEM tests and analysis that we believe to be reliable. However, in no event, shall SEM be liable for the inaccuracies or omissions contained therein. In all cases, details and values should be verified by the customer.

Part Number Guideline

EXXSNMXXXXHF

S: specifies Silicone foam.

N: specifies the fabric type (3: NiCu-C70 Ripstop Fabric, 4: NiCu-C12 Plain Weave Fabric).

M: specifies the finishing/attachment system (refer to page 6 Part Number Guide).

XXXXX: specifies length in the form XXX.XX".

Schlegel Electronic Materials (SEM) introduces NEW Conductive Foam (CF). SEM conductive foam, a highly resilient Nickel-Copper plated polyurethane foam, is sandwiched between SEM's knitted and non-woven conductive fabrics to form industry leading substrate for die-cut gaskets. CF material is ideal for applications that require surface conformity with excellent cavity-to-cavity EMI shielding, superior conductivity under low compression forces and better shielding effectiveness at very high frequencies. CF gaskets are precision die-cut with a back-layer of either conductive or non-conductive pressure-sensitive-adhesive (PSA).

Schlegel's manufacturing and metal plating processes enhance the material integrity of the SEM Conductive Foam and ensure excellent galvanic compatibility even for large surface applications like I/O gaskets. The through-conductivity achieved with Schlegel CF increases the shielding effectiveness at high frequencies by shortening the return current path between the flanges.

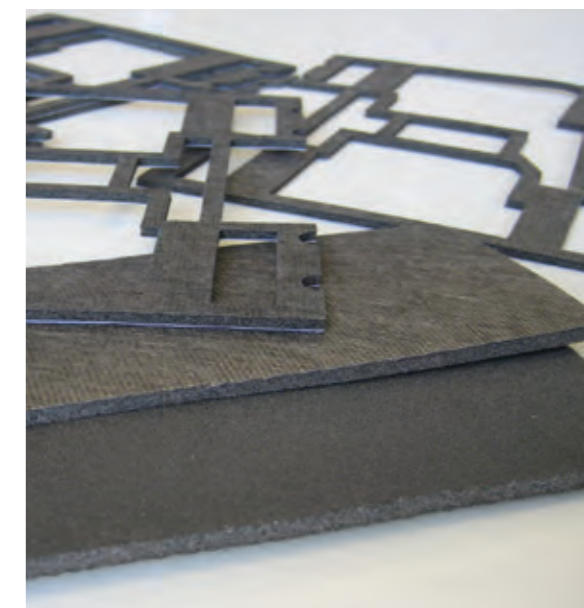

| Conductive fabrics over Nickel-Copper plated polyurethane foam | |
|--|--|
| Dimensions | Maximum Width: 22" (560mm) Thicknesses: 0.02", 0.04", 0.06", 0.09", 0.13", 0.20" (0.45mm, 1.00mm, 1.5mm, 2.3mm, 3.4mm, 5.0mm) Other thicknesses may be available. Please contact your SEM Representative. |
| Operating Temperatures | -40°F - 156°F (-40°C - +70°C) in accordance with ASTM D3374 (Standard test methods for flexible cellular materials) |
| Surface Resistivity | <0.08 Ohm/sq. |
| Compression set | <15% (compressed at 50% during 22 Hrs. @70°C) |
| Tensile Strength | 15 kg/inch (CF-78-30FR) |
| Flammability | UL94-V0/V1 – See details at www.UL.com (SEM FE – Plastic component QMFZ2. E313523) |
| Aging | No change in surface resistivity after exposure to 60°C - 90%RH – 300 hrs |
| Shielding Effectiveness | >90 dB AVG. 10-1000 MHz (Tem-T Cells-Method described in IEEE Std 1302) |
| Compliance | 2011/65/EU (RoHS 2.0) compliant |

| Thickness | Tolerance | UL Fire Rated | Part # |
|-----------|-----------|---------------|------------|
| 0.45mm | ± 0.2mm | - | CF-78-05NR |
| 1.00mm | ± 0.2mm | UL94-V0 | CF-78-10FR |
| 1.50mm | ± 0.2mm | UL94-V0 | CF-78-14FR |
| 1.50mm | ± 0.2mm | - | CF-78-14NR |
| 2.30mm | ± 0.3mm | UL94-V0 | CF-78-20FR |
| 2.30mm | ± 0.3mm | - | CF-78-20NR |
| 3.40mm | ± 0.3mm | UL94-V1 | CF-78-30FR |
| 3.40mm | ± 0.3mm | - | CF-78-30NR |
| 5.00mm | ± 0.5mm | - | CF-78-50NR |

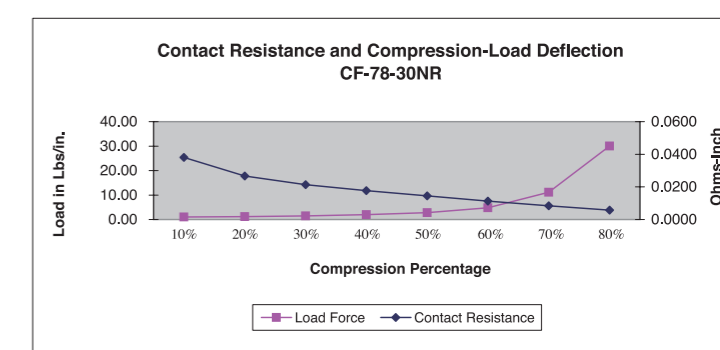

THE RIGHT SHIELDING PRODUCT FOR DIE-CUT I/O APPLICATIONS

Information Technology Equipment and other electronic devices must comply with various international radiated emissions and susceptibility requirements. Under specific conditions, FCC part 15 (US) requires such equipment to pass stringent regulations up to 40 GHz. Most unintentionally-radiated emissions are from field leakage at various chassis external interfaces, or from unbalanced differential signals; containment of both require shielding materials to provide a low impedance path despite the broadband and/or high frequency operation of such devices. Simultaneously, these electronic devices are sensitive to various susceptibility requirements, including electrostatic discharge (ESD, e.g., IEC 61000-4-2), and, in some cases, must resist to applied voltages as high as 15 kV. In this instance, the same shielding materials must also feature a very low impedance/resistance at very low frequencies to ensure a harmless discharge path exists to allow the charge to flow from the I/O connectors to the exterior of the chassis, and then safely away from the devices.

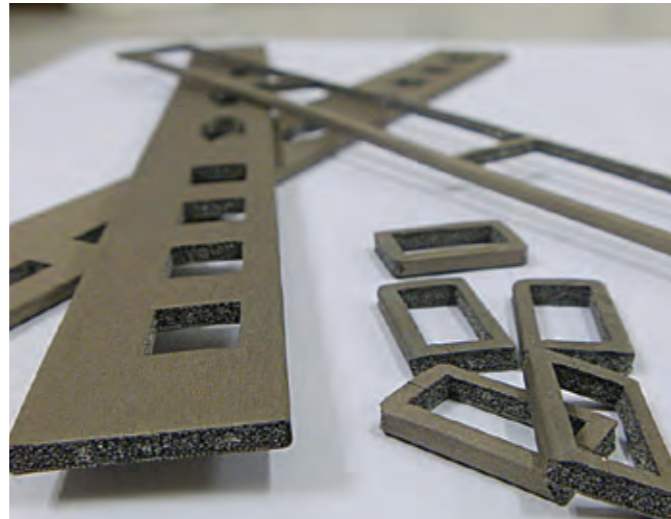

Schlegel Electronic Materials (SEM) introduces ORS-II, a new series of gaskets specially designed for broadband applications. By combining its famous nickel copper plated conductive foam and its high-end nickel copper C12 flexible fabric cladding, ORS-II offers minimal surface resistance to achieve superior grounding and shielding results at low frequencies. By offering excellent Z-conductivity to close the cavities in the chassis openings, ORS-II also ensures substantial shielding performance at high frequencies.

ORS-II is available in a variety of thicknesses, which are die-cut to customer specifications, for a durable highly conductive product in all X-Y-Z axes. In addition, shielding efficiency is achieved with less sensitivity to compression variances than other traditional shielding products. ORS-II is available with a UL94-V0 flammability rating and complies with RoHS 2.0 European Directive and SVHC Policy (REACH).

All these features combined in one product makes ORS-II a great engineering solution when addressing all types of shielding challenges which are present in broadband and high-speed applications.

ORS-II is available in a multitude of geometries and in varying thicknesses. ORS-II is recommended for all combinations of I/O connectors, is particularly effective when broadband emissions and/or susceptibility are of concern, and is far more effective than standard conductive foam when superior grounding is important.

TECHNICAL SPECIFICATIONS

| | | |
|-------------------------------------|---|----------------------------------|
| Shielding Effectiveness 0.1 – 40GHZ | See Graph | Stripline method (IEEE std 1302) |
| Operation Temperature | -40°F +156°F (-40°C +70°C) | |
| Flammability | UL94 V0 | UL94 |
| Surface Resistivity | <= 0.024 Ohm/sq.: NiCu-C12 <= 0.08 Ohm/sq.: NiCu-C22 | SEM LP 3004 |
| Contact Resistance (@ 1Kg load) | <0.08 Ohm-inch : NiCu-C12 <0.2 Ohm-inch : NiCu-C22 | SEM LP 3001 |
| Abrasion Resistance | 1.000.000 cycles | ASTM D3886 |
| Thicknesses (mm) | 1.00, 1.50, 2.30, 3.40, 5.00 | |

Shielding effectiveness of ORS-II versus current shielding materials

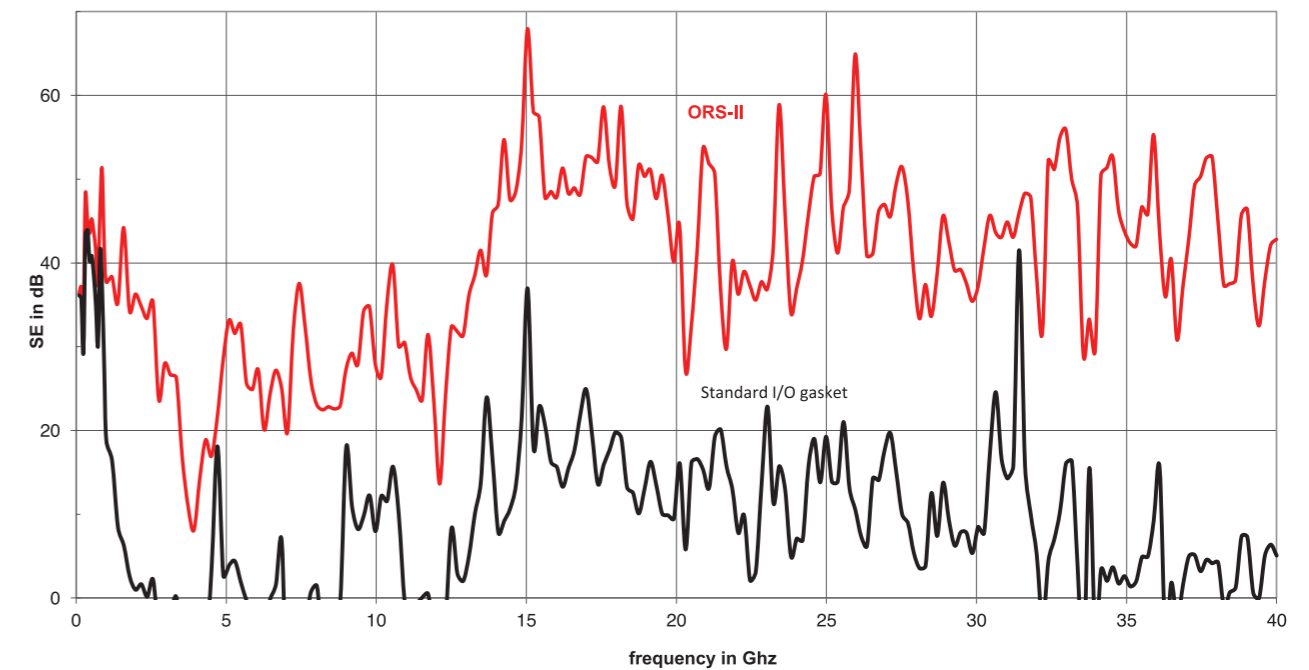

Schlegel Electronic Materials (SEM) EEH Series' gaskets have been specially designed to provide environmental sealing as well as EMI shielding for outdoor electronic cabinets. EEH gaskets are Fabric over EPDM (Ethylene Propylene Diene Monomer) sponge rubber cores extruded over a galvanized wire core for flange mounting. This product provides cost savings to manufacturers assembly lines, as labor costs are substantially reduced as they are able to use one EEH gasket instead of two different gaskets.

EEH series' gaskets are designed to ease mounting through special reinforced clips which can accommodate a wide variety of metal thicknesses. The gasket can be picture framed to ensure continuously environmental sealing in the corners. EEH profiles and materials excel in dynamic or high cycling applications such as front doors or access panels with low compression rates and very limited compression set. An operating temperature range of EPDM starts from -40°C to 100°C, and the material has good resistance to UV, water and acids etc.

SEM recommends half-wrapped EPDM for environmental and EMI protection using our corrosion resistant SnCu-C50 fabric. We also offer a full range of alternative combinations, please contact your local office for design help and advice.



| Part Number | FW: Full Wrap HW: Half Wrap N: None | Fabric | Type | Flange Thickness |
|-------------|---|-----------|------|------------------|
| EW10.00019 | FW | SnCu-C50 | A | 1-3.3 |
| EW10.00020 | FW | SnCu-C50 | B | 1-4.8 |
| EW10.00021 | FW | SnCu-C50 | C | 1.5-3.6 |
| EW10.00022 | FW | SnCu-C50 | D | 1-4.8 |
| EW10.00001 | FW | NiCu-C12 | A | 1-3.3 |
| EW10.00013 | FW | NiCu-C12 | B | 1-4.8 |
| EW10.00005 | FW | NiCu-C12 | C | 1.5-3.6 |
| EW10.00009 | FW | NiCu-C12 | D | 1-4.8 |
| EW10.00002 | FW | NiCu-C70 | A | 1-3.3 |
| EW10.00014 | FW | NiCu-C70 | B | 1-4.8 |
| EW10.00006 | FW | NiCu-C70 | C | 1.5-3.6 |
| EW10.00010 | FW | NiCu-C70 | D | 1-4.8 |
| EW10.00015 | FW | AgRs-C2 | A | 1-3.3 |
| EW10.00016 | FW | AgRs-C2 | B | 1-4.8 |
| EW10.00017 | FW | AgRs-C2 | C | 1.5-3.6 |
| EW10.00018 | FW | AgRs-C2 | D | 1-4.8 |
| EW10.00023 | FW | NiCu-C22 | A | 1-3.3 |
| EW10.00024 | FW | NiCu-C22 | B | 1-4.8 |
| EW10.00025 | FW | NiCu-C22 | C | 1.5-3.6 |
| EW10.00026 | FW | NiCu-C22 | D | 1-4.8 |
| EW20.00026 | HW | SnCu-C50 | A | 1-3.3 |
| EW20.00027 | HW | SnCu-C50 | B | 1-4.8 |
| EW20.00028 | HW | SnCu-C50 | C | 1.5-3.6 |
| EW20.00029 | HW | SnCu-C50 | D | 1-4.8 |
| EW20.00003 | HW | NiCu-C12 | A | 1-3.3 |
| EW20.00015 | HW | NiCu-C12 | B | 1-4.8 |
| EW20.00007 | HW | NiCu-C12 | C | 1.5-3.6 |
| EW20.00011 | HW | NiCu-C12 | D | 1-4.8 |
| EW20.00004 | HW | NiCu-C70 | A | 1-3.3 |
| EW20.00016 | HW | NiCu-C70 | B | 1-4.8 |
| EW20.00008 | HW | NiCu-C70 | C | 1.5-3.6 |
| EW20.00012 | HW | NiCu-C70 | D | 1-4.8 |
| EW20.00018 | HW | AgRs-C2 | A | 1-3.3 |
| EW20.00019 | HW | AgRs-C2 | B | 1-4.8 |
| EW20.00020 | HW | AgRs-C2 | C | 1.5-3.6 |
| EW20.00021 | HW | AgRs-C2 | D | 1-4.8 |
| EW20.00022 | HW | NiCu-C22 | A | 1-3.3 |
| EW20.00023 | HW | NiCu-C22 | B | 1-4.8 |
| EW20.00024 | HW | NiCu-C22 | C | 1.5-3.6 |
| EW20.00025 | HW | NiCu-C22 | D | 1-4.8 |
| EW00.00001 | N | EPDM ONLY | A | 1-3.3 |
| EW00.00002 | N | EPDM ONLY | B | 1-4.8 |
| EW00.00003 | N | EPDM ONLY | C | 1.5-3.6 |
| EW00.00004 | N | EPDM ONLY | D | 1-4.8 |

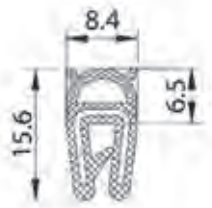

A

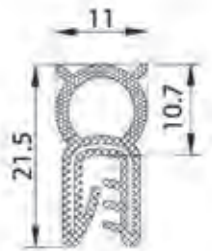

B



C

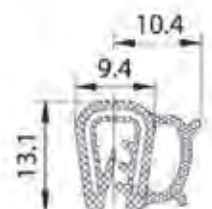

D

Material Properties

| Material Properties | Testing Method /Standards | EPDM Rubber Sponge-PG61 | EPDM Rubber Solid-PG281 |
|--|--|-------------------------|-----------------------------|
| Density | DIN 53479 /DIN 63505 (PG281) | 0.60 g/m ³ | 1.26±0.02 g/cm ³ |
| Hardness | DIN 53519-1,2, ISO 1183 (PG281) | – | 60±5 |
| Tensile Strength | ISO 37, DIN 53504 | >1.5 N/mm ² | >8 N/mm ² |
| Elongation off | ISO 37, DIN 53504 | >300% | >400% |
| Air Ageing- 72 hours / 100°C | ISO 188:1998, ISO 188:2006 | CHANGED VALUES | |
| Hardness Shore A - (Changed values) | DIN 53519-1,2, ISO 1183 (PG281) | – | ±5 |
| Tensile Strength (Changed values) | DIN ISO 34 | 3.1 N/mm ² | 9.0 N/mm ² |
| Elongation off (Changed values) | DIN ISO 34 | >100% | 100% |
| Temperature Range (application) | -40°C To + 100°C | | |
| Flash Point | 250°C | | |
| Clamping range | Flange thickness from 1.5mm to 4.8mm | | |
| Sealing suitability | Level of IP according to design | | |
| Length of supply | 25 mts per roll | | |
| Resistance to Chemical & Weather Conditions | Alcohol, ozone, mild acids, acetone & Alkali | | |



EEH serie can be supplied in frames with 90° angles and bonded with thermo plastic elastomer. This process preserves the environmental sealing properties of the gasket in the corners.

EW XX YZ F LLLLL / WWWW (*)

XX: HW / FW

Y: Type of profile (A-B-C-D)

Z: 1: SnCu-C50 / 2: NiCu-C70 / 3: NiCu-C12 / 4: AgRs-C2 / 5: NiCu-C22

LLLLL **: Length in inches (LLL,LL")

WWWWW **: Width in inches (WWW,WW")

(*): Please consult SEM representative to confirm availability of any combination

(**): External dimensions of the frame

SEM ENVIRONMENTAL EMI HYBRID GASKET FOR RAILWAYS APPLICATIONS EUROPE

In order to guarantee the same level of security in railways vehicles in the European Union in the event of a fire on board, the CENELEC (TC 256) has released a standard EN 45545 which has become a national standard for all member states. The standard specifies the level of safety (HLx: Hazard Level) according to the requirements (location, application) and the type of vehicles (OC: Operation Category). The level of safety (HL1, HL2 or HL3) will depend on the results obtained by the materials on specific test for level of oxygen index, smoke emanation and toxicity. For further information on the subject, please refer to the standard. For EN 45545-2, Schlegel Electronic Materials EEH gasket's materials are to comply with R22/ R23 requirements (longitudinal seals such as window seals, door joints and panel connections) and is rated HL2 (see details on the following table).

By the combination of EN 45545 rated EPDM core material and a wide choice of very conductive claddings, Schlegel Electronic Materials provide a cost effective solution to meet the EMC requirements for Railways applications according to EN 50121.

Part Number

EWXX.XXXXX R for the standard profiles

EW XX YZ F LLLLL/WWWWW R for frames (See details on page 29)

SPECIFICATIONS

| EW20.00026R | | | | Sponge Solid | |
|---|----------------|-------------------|--------------------------|------------------|------------------|
| RAILWAYS | | | | | |
| Environmental EMI Hybrid Gasket | | | | | |
| EPDM EXTRUSION COMPOUND | SPECIFICATION | UNIT | Requirement | HexFlame 45-1000 | HexFlame 45-7000 |
| Elastomer/Polymer | | | | EPDM SOLID | EPDM SPONGE |
| Curing | | | | Sulphur | Sulphur |
| Color | | | Black | Black | Black |
| Specific Gravity | DIN 53479 | g/cm ³ | | +/- 1.51 | +/- 0.8 |
| Hardness | DIN 53505 | shore A | | 64 | N/A |
| Tensile strength | DIN 53504 | N/mm ² | | ca.5 | - |
| Elongation at break | DIN 53504 | % | | >400 | - |
| Tear Strength | DIN 53507-A | N/mm | | ca.5 | - |
| Ozon resistance | DIN 53509 | | | Resistant | Resistant |
| Nitrosamine | | ppm | | none | none |
| Halogens | | ppm | | none | none |
| Flammability | EN 45545-2 | | Class | R22/23,HL3 | R22/23,HL2 |
| Smoke density/Gas analysis | EN ISO 5659-2 | Max. | <=150 (HL3), <300 (HL2) | 54 | 102.35 |
| Oxygen index | ISO 4589-2 | % | >=32 (HL3), >28 (HL2) | 33.8 | 31.1 |
| Toxicity | NF X70-100-1&2 | CIT NLP | <=0.75 (HL3), <0.9 (HL2) | 0.64 | 0.54 |
| Test results determined on vulcanized (10 min./180°C) 2 and 6 mm thick sheets | | | | | |
| Identification : ' SEM EN 45545' printed in yellow on the clip area | | | | | |

MORE FLEXIBILITY, HIGHER CONDUCTIVITY, AND EASIER INSTALLATION

SEM's expanded line of Conductive Tapes meets the customer needs for flexibility, higher conductivity, and easier installation. SEM Conductive Tapes feature superior shear strength, 7.6 kPa (72+ hours @ 1.1 psi) in accordance to (PSTC #7) ASTM D 3654, and peel strength, from 10.2 N/2.5 cm (36.07 oz/inch width) to 20.3 N/2.5cm (71.8 oz/inch width) in accordance to (PSTC #1) ASTM D 3330 when compared to other EMI shielding tapes. This is made possible by a unique, cross-linking acrylic based, conductive Pressure Sensitive Adhesive (PSA) that also allows the tapes to be designed into higher temperature applications. Low temp application is possible down to 10°F (-12°C), and excessive pressure is not required for application to the end unit. There is now an easy-to-apply tape to fit most every EMI shielding design need.

Conductive Silver Tapes (CST)

HIGHER CONDUCTIVITY WITHOUT THE SHARP EDGES

The foundation of SEM's tape products is Conductive Silver Fabric Tape. CST offers superb conductivity and ease of installation for a wide range of applications. The smooth, soft-edged tape will not crack after repeated flexing, or cause injuries. SEM CST achieves total coverage, even on irregular surfaces and experiences no significant shrinkage at temperatures up to 180°C (356°F). A unique, conductive Pressure Sensitive Adhesive (PSA) allows the tapes to be designed into higher temperature applications. The PSA is fire rate to UL 510, and excessive pressure is not required for application to the end unit.

CST tape has an average shielding effectiveness of 70 dB in the range of 20 MHz to 10 GHz. CST's protective C2 coating lowers the cathodic potential of the silver to make it galvanically compatible with a variety of EMI gaskets and cabinet surfaces. A superior alternative to sharp, non-conforming foil tapes, SEM's lightweight Conductive Silver Tape is ideal for grounding and for sealing small apertures in frames.

For assemblers, the CST's soft fabric is safe and easy to work with, and it stays firmly in place with SEM's strong, high-tack conductive adhesive. The conductive fabric base also allows the tape to be custom-cut in virtually any unique shape with simple, inexpensive tooling.



| Sizes | | |
|-----------------|-----------------------|-------------|
| Tape Width | Tape Length | Part Number |
| 0.315" (8mm) | 18 yard (16.45m) roll | 5941-0031-0 |
| 0.500" (12.7mm) | 18 yard (16.45m) roll | 5941-0050-6 |
| 0.788" (20mm) | 18 yard (16.45m) roll | 5941-0079-8 |
| 1.000" (25.4mm) | 18 yard (16.45m) roll | 5941-0100-3 |
| 1.180" (30mm) | 18 yard (16.45m) roll | 5941-0118-2 |
| 2.000" (50.8mm) | 18 yard (16.45m) roll | 5941-0200-5 |

Specifications

- Fabric: Silver woven nylon ripstop fabric with C2 anti-corrosion coating.
- Adhesive: High-tack, conductive adhesive system.
- Surface Resistivity: $\leq 0.5\Omega/\text{sq}$. Test Method: ASTM F390 modified.
- Resistivity through adhesive: ≤ 120 milliohms/square inch.
- Low Temperature Application: -40°F (-40°C).
- Abrasion Resistance: No change in surface resistivity and no fabric degradation after more than 800,000 wear cycles. Test Method: ASTM D3886.
- Peel Strength Test Method ASTM D3330:
45.80 oz per inch (1.62g per mm) @ 1 hour dwell initial.
47.47 oz per inch (1.67g per mm) @ 24 hour dwell initial.
- Shielding Effectiveness: 95dB. Test method: Mil DTL 83528C.

Conductive Mask & Peel Tape (CMP)

SHIELD ENCLOSURES SAFELY AND EFFICIENTLY

SEM's Conductive Mask & Peel (CMP) tape simplifies the manufacture of painted enclosures. CMP is constructed of impenetrable, heat-release mask, highly conductive nickel copper fabric and strong high-tack, conductive adhesive, which secures the tape to the metal for superior EMI shielding. The tape employs Press, Paint, and Peel application and provides total coverage. The CMP tape's volume resistance is in the range of 0.8 - cm [average]. When CMP is used with SEM shielding gaskets, a highly conductive pathway is obtained, and provides excellent galvanic capability between mating surfaces. Typical applications include large cabinets, factory automation equipment and data storage units.

Press, Paint and Peel application is simple, safe, and secure. The operator removes the release liner from the back of the fabric tape and applies it to the prepared bare metal surface. No sharp edges exist that could lead to injuries. The 2-mil polyimide mask prevents infiltration of paint during the spraying or powder-coat process. Enclosures with CMP can be baked at temperatures up to 180°C (356°F) for up to 30 minutes. The low-tack mask releases during baking so it can be easily be removed to reveal the highly conductive fabric surface.



| Sizes | | |
|------------------|---------------------|-------------|
| Tape Width | Tape Length | Part Number |
| 0.315" (8.0 mm) | 36 yard (33m) rolls | 5935-0031-4 |
| 0.500" (12.7 mm) | 36 yard (33m) rolls | 5935-0050-0 |
| 0.788" (20.0 mm) | 36 yard (33m) rolls | 5935-0079-4 |
| 1.000" (25.4 mm) | 36 yard (33m) rolls | 5935-0100-7 |
| 1.180" (30.0 mm) | 36 yard (33m) rolls | 5935-0118-8 |
| 1.570" (40.0 mm) | 36 yard (33m) rolls | 5935-0157-6 |
| 2.000" (50.8 mm) | 36 yard (33m) rolls | 5935-0200-9 |
| 2.500" (63.5 mm) | 36 yard (33m) rolls | 5935-0250-4 |

Specifications

- Fabric: Woven copper nickel fabric.
- Adhesive: High-tack, aggressive conductive adhesive system.
- Surface Resistivity: $\leq 0.024\Omega/\text{sq}$.
- Resistivity through adhesive: ≤ 10 milliohms/square inch.
- Low Temperature Application: -40°F (-40°C).
- Abrasion Resistance: No change in surface resistivity after more than 1,000,000 wear cycles. Test method: ASTM D3886.
- Shrinkage: <1% @ 180°C (356°F) for 30 minutes. Test Method: LP-3012.
- Peel Strength: 50 oz. Per inch minimum initial. Test Method: ASTM D3330.
- Shielding Effectiveness: 97.4dB. Test method: Mil DTL 83528C.

Conductive NiCu Fabric Tape (CFT)

SEM's CFT is made from the same woven copper nickel fabric as its CMP and has the same conductive and galvanic capabilities. The nickel copper fabric, along with SEM's aggressive high temperature resistant conductive PSA, is designed specifically for applications that do not require a mask, i.e., cabinets that are not going to be painted or powder coated.

| Sizes | | |
|------------------|---------------------|-------------|
| Tape Width | Tape Length | Part Number |
| 0.315" (8.0 mm) | 36 yard (33m) rolls | 5927-0031-0 |
| 0.500" (12.7 mm) | 36 yard (33m) rolls | 5927-0050-6 |
| 0.788" (20.0 mm) | 36 yard (33m) rolls | 5927-0079-2 |
| 1.000" (25.4 mm) | 36 yard (33m) rolls | 5927-0100-3 |
| 1.180" (30.0 mm) | 36 yard (33m) rolls | 5927-0118-8 |
| 1.570" (40.0 mm) | 36 yard (33m) rolls | 5927-0157-2 |
| 2.000" (50.8 mm) | 36 yard (33m) rolls | 5927-0200-5 |

Specifications

- Fabric: Woven copper nickel fabric.
- Adhesive: High-tack, aggressive conductive adhesive system.
- Surface Resistivity: $\leq 0.024\Omega/\text{sq}$.
- Resistivity through adhesive: ≤ 10 milliohms/square inch.
- Low Temperature Application: -40°F (-40°C).
- Abrasion Resistance: No change in surface resistivity after more than 1,000,000 wear cycles. Test method: ASTM D3886.
- Shrinkage: <4% @ 180°C (356°F) temperature.
- Peel Strength: 50 oz. Per inch minimum initial. Test Method: ASTM D3330.
- Shielding Effectiveness: 97.4dB. Test method: Mil DTL 83528C.

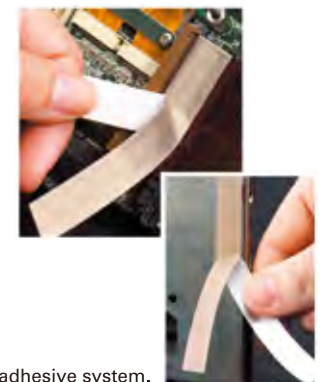

Conductive NiCu-C70 Rip-stop Fabric Tape (CFTII)

Schlegel Electronic Materials (SEM)'s CFT(II) is made of using polyester rip-stop copper nickel fabric with high conductivity PSA. CFT (II) have an average shielding effectiveness over 96 dB in the frequency ranges from 20 MHz to 10 GHz. In addition to the easy-to-apply properties to fit the most EMI shielding design, it is also ideal for grounding and sealing purpose. And it is the most economical by comparing to other SEM Conductive Tapes.



Specifications

- Fabric: Nickel-Copper plated polyester ripstop fabric.
- Adhesive: High-tack, conductive adhesive system.
- Surface Resistivity: $\leq 0.066\Omega/\text{sq}$.
- Resistivity through adhesive: ≤ 80 milliohms/square inch.
- Low Temperature Application: -40°F (-40°C).
- Abrasion Resistance: No change in surface resistivity after more than 1,000,000 wear cycles. Test method: ASTM D3886.
- Shrinkage: $<4\%$ @ 180°C (356°F) temperature.
- Peel Strength: 50 oz. Per inch minimum initial. Test Method: ASTM D3330.
- Shielding Effectiveness: 96dB. Test method: Mil DTL 83528C.

| Sizes | | |
|------------------|---------------------|-------------|
| Tape Width | Tape Length | Part Number |
| 0.315" (8.0 mm) | 36 yard (33m) rolls | 5923-0031-0 |
| 0.500" (12.7 mm) | 36 yard (33m) rolls | 5923-0050-6 |
| 0.788" (20.0 mm) | 36 yard (33m) rolls | 5923-0079-2 |
| 1.000" (25.4 mm) | 36 yard (33m) rolls | 5923-0100-3 |
| 1.180" (30.0 mm) | 36 yard (33m) rolls | 5923-0118-8 |
| 1.570" (40.0 mm) | 36 yard (33m) rolls | 5923-0157-2 |
| 2.000" (50.8 mm) | 36 yard (33m) rolls | 5923-0200-5 |

Black Conductive NiCu-C22 Fabric Tape



Schlegel Electronic Materials (SEM) offers the Black Conductive NiCu Fabric Tape which is similar to CFT(II) but blackened for the cosmetic purposes. The blackened conductive fabric was in rip-stop pattern with surface resistivity lower than 0.08 ohm/sq. The average shielding effectiveness over 95.76 dB in the frequency ranges from 20 MHz to 10 GHz. It provides the alternative to customer who prefer the black color conductive tape for the appearance design but not necessary to have silver content inside as Conductive Silver Tape (CST).

Sizes

| Tape Width | Tape Length | Part Number |
|------------------|---------------------|-------------|
| 0.315" (8.0 mm) | 36 yard (33m) rolls | 5921-0031-0 |
| 0.500" (12.7 mm) | 36 yard (33m) rolls | 5921-0050-6 |
| 0.788" (20.0 mm) | 36 yard (33m) rolls | 5921-0079-2 |
| 1.000" (25.4 mm) | 36 yard (33m) rolls | 5921-0100-3 |
| 1.180" (30.0 mm) | 36 yard (33m) rolls | 5921-0118-8 |
| 1.570" (40.0 mm) | 36 yard (33m) rolls | 5921-0157-2 |
| 2.000" (50.8 mm) | 36 yard (33m) rolls | 5921-0200-5 |

Specifications

- Fabric: Nickel-Copper plated polyester ripstop fabric.
- Adhesive: High-tack, conductive adhesive system.
- Surface Resistivity: $\leq 0.08\Omega/\text{sq}$.
- Resistivity through adhesive: ≤ 20 milliohms/square inch.
- Low Temperature Application: -40°F (-40°C).
- Abrasion Resistance: No change in surface resistivity and no fabric degradation after more than 1,000 wear cycles. Test method: ASTM D3884.
- Shrinkage: $<4\%$ @ 180°C (356°F) temperature.
- Peel Strength: 50 oz. Per inch minimum initial. Test Method: ASTM D3330.
- Shielding Effectiveness: 95.76dB. Test method: Mil DTL 83528C.

Conductive SnCu-C50 Fabric Tape

Schlegel Electronic Materials (SEM) offers the Conductive SnCu Fabric Tape which is made of Tin copper plain weave woven fabric with high conductivity PSA. This provides the good galvanic compatibility for most common materials and higher corrosion resistance which target for outdoor application. The average shielding effectiveness of conductive SnCu fabric tape is over 95.3 dB in the frequency ranges from 20 MHz to 10 GHz and the surface resistivity is less than 0.02 ohm/sq.



Sizes

| Tape Width | Tape Length | Part Number |
|------------------|---------------------|-------------|
| 0.315" (8.0 mm) | 36 yard (33m) rolls | 5926-0031-0 |
| 0.500" (12.7 mm) | 36 yard (33m) rolls | 5926-0050-6 |
| 0.788" (20.0 mm) | 36 yard (33m) rolls | 5926-0079-2 |
| 1.000" (25.4 mm) | 36 yard (33m) rolls | 5926-0100-3 |
| 1.180" (30.0 mm) | 36 yard (33m) rolls | 5926-0118-8 |
| 1.570" (40.0 mm) | 36 yard (33m) rolls | 5926-0157-2 |
| 2.000" (50.8 mm) | 36 yard (33m) rolls | 5926-0200-5 |

Specifications

- Fabric: Tin Copper plated nylon plain weave fabric.
- Adhesive: High-tack, conductive adhesive system.
- Surface Resistivity: $\leq 0.020\Omega/\text{sq}$.
- Resistivity through adhesive: ≤ 40 milliohms/square inch.
- Low Temperature Application: -40°F (-40°C).
- Abrasion Resistance: No change in surface resistivity and no fabric degradation after more than 1,000 wear cycles. Test method: ASTM D3884.
- Shrinkage: $<4\%$ @ 180°C (356°F) temperature.
- Peel Strength: 50 oz. Per inch minimum initial. Test Method: ASTM D3330.
- Shielding Effectiveness: 95.3dB. Test method: Mil DTL 83528C.

I/O SHIELDING FOR ALL STANDARD SIZES

Sized to fit standard D-Subminiature connectors, installation-friendly SEM shielding gaskets enhance the performance of EMI shielding for I/O backplanes. Made of highly conductive fabric clad foam, SEM's I/O shielding gaskets provide multiple contact points to maintain conductivity and compensate for tolerance stackup. Pressure-sensitive adhesive is available, but not usually required for installation. There is no need to contend with sharp-edged metal shields- simply slip the gaskets over the connector and secure.

With no tooling costs, easy installation, and off-the-shelf availability, these gaskets are a simple and efficient solution to I/O EMI shielding.

Available D-SUB connector to EMI shielding gaskets include:

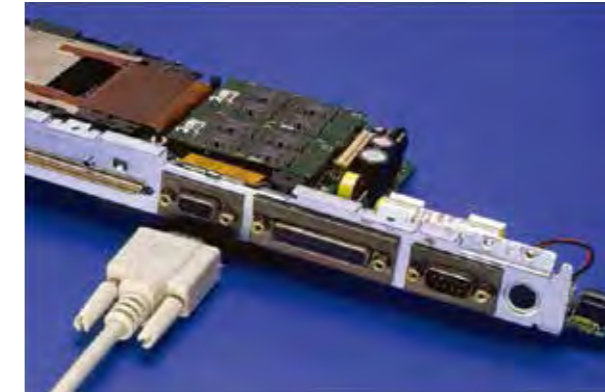

| P/N | TYPE | Pin | Thickness |
|-------------|-------|-----|--------------|
| E29XYG-0131 | D-SUB | 9 | 0.04" (1 mm) |
| E58XYG-0131 | D-SUB | 9 | 0.08" (2 mm) |
| E29XYG-0164 | D-SUB | 15 | 0.04" (1 mm) |
| E58XYG-0164 | D-SUB | 15 | 0.08" (2 mm) |
| E29XYG-0219 | D-SUB | 25 | 0.04" (1 mm) |
| E58XYG-0219 | D-SUB | 25 | 0.08" (2 mm) |
| E29XYG-0283 | D-SUB | 37 | 0.04" (1 mm) |
| E58XYG-0283 | D-SUB | 37 | 0.08" (2 mm) |
| E29XYG-0274 | D-SUB | 50 | 0.04" (1 mm) |
| E58XYG-0274 | D-SUB | 50 | 0.08" (2 mm) |

X: Foam type (1: UL 94-HB, 5: UL-94V0, 7: UL94-V0 Ultrasoft)

Y: Fabric (3: NiCu-C70, 4: NiCu-C12, 9: AgC2)

9 pin

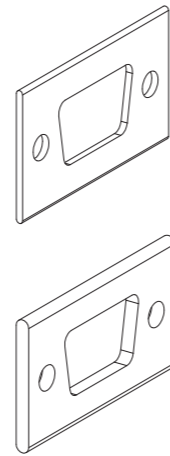
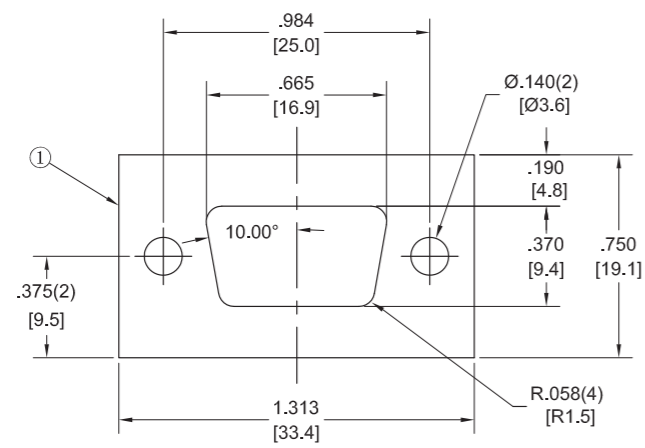

37 pin

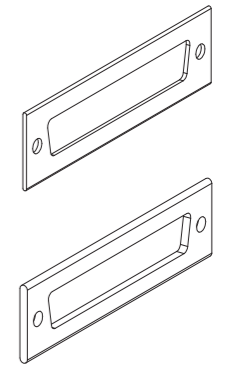
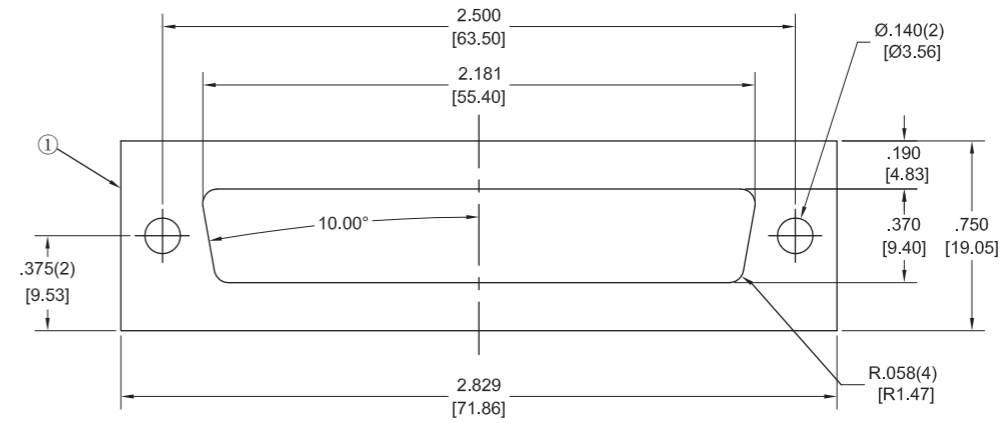

15 pin

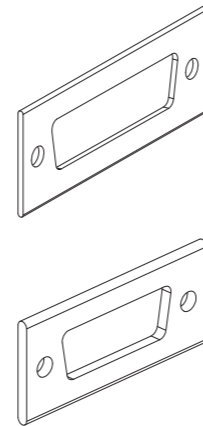
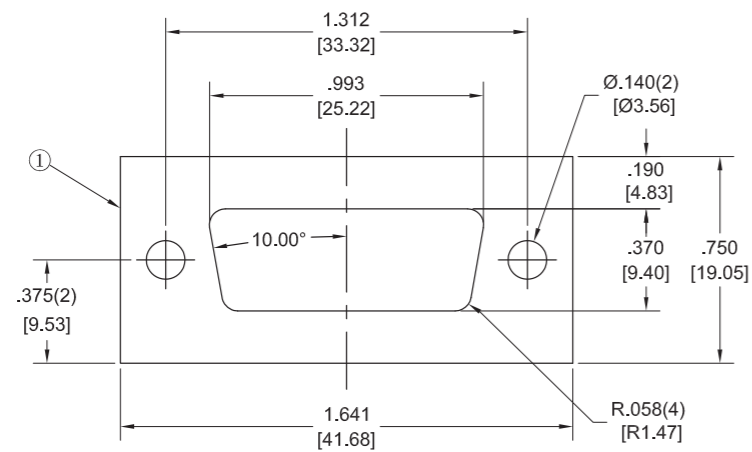

50 pin

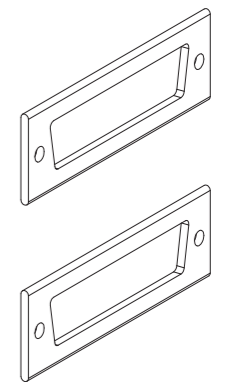
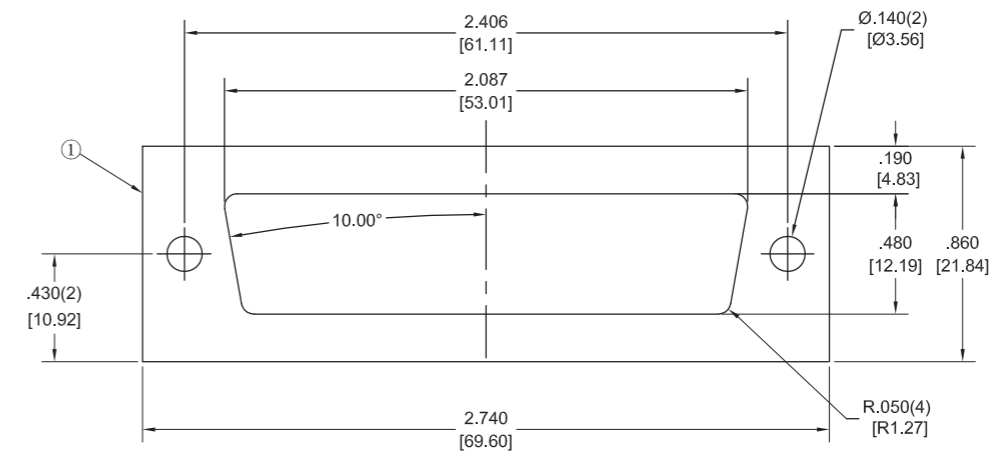

25 pin

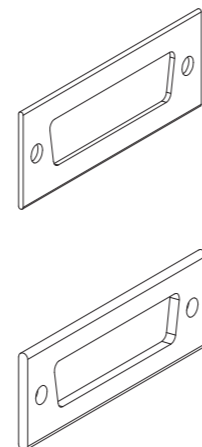
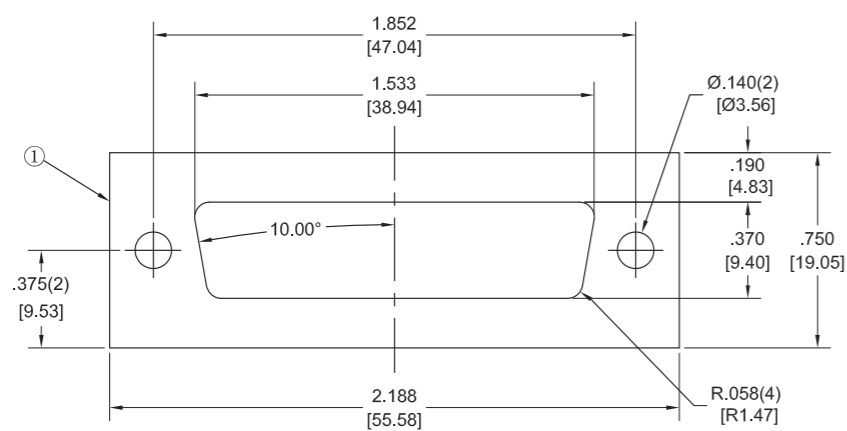

Schlegel Electronic Materials (SEM) recommends the use of non conductive adhesives in most cases (type R). All gaskets have a PSA width recommended according to the width of the profile to ensure sufficient direct contact at the bottom of the gasket with the application. Test was carried out according to SAE ARP 6248 (stripline method) on EW8 (9/3 mm) in order to measure the influence of non conductive PSA (2.5 mm and 4.5 mm wide) and conductive PSA (8 mm wide). Three profiles were tested compressed at 50% up to 40 GHz:

- EW873 + 2.5 mm R tape
- EW873 + 4.5 mm R tape
- EW873 + 8 mm D tape

Conductive PSA are usually a tradeoff between electrical conductivity and tackiness. In fact the more conductive particles embedded into the adhesive, the less tackiness and vice versa. Test results show clearly the influence of the width of the non conductive adhesive on the shielding characteristics and the poor results when the bottom surface is almost completely covered by conductive adhesive. The use of conductive adhesive should therefore be restricted to very small profiles where limited width prevent from the use of non conductive adhesive. Even for Z conductive foam, Schlegel Electronic Materials recommends the mounting of strips of non conductive adhesives.

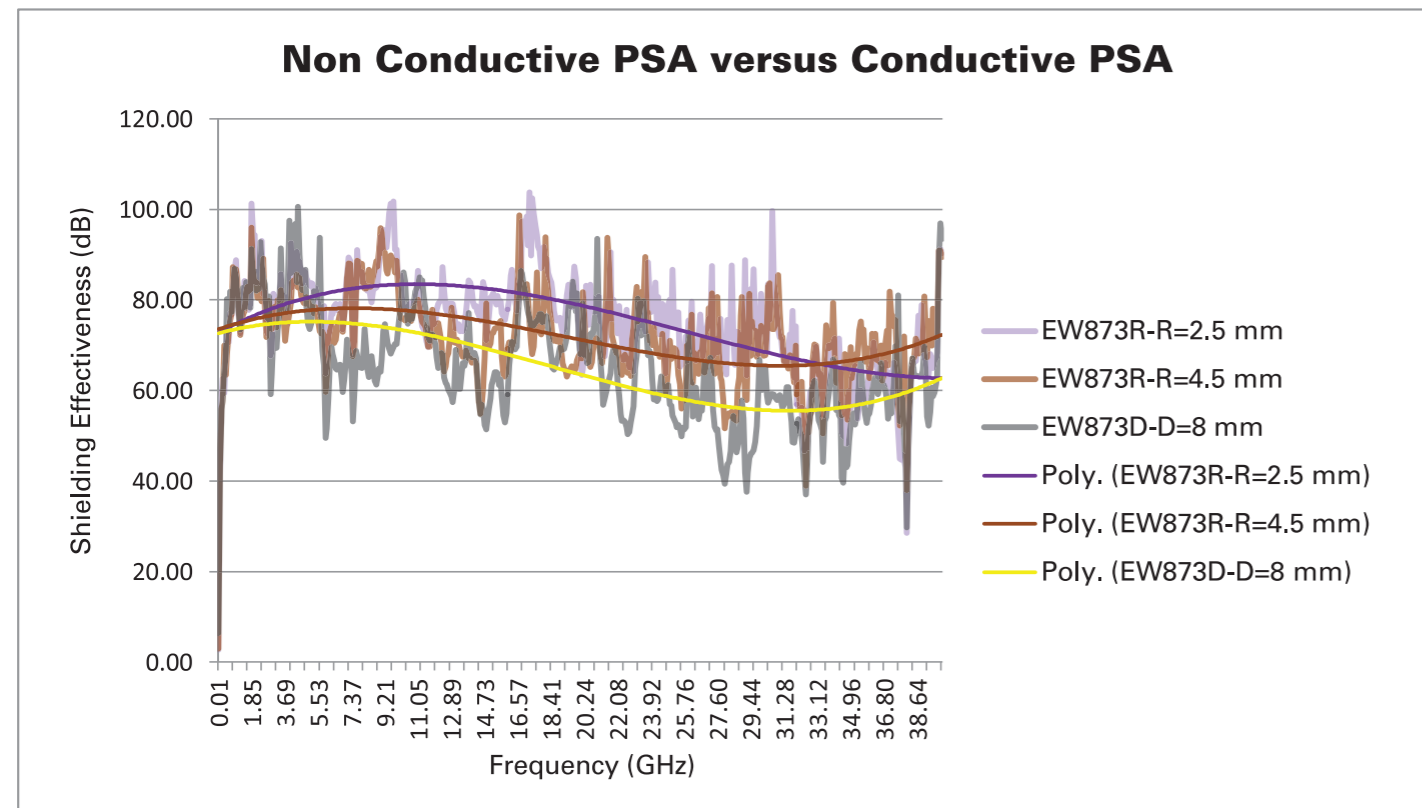

1. Pressure Sensitive Adhesive (PSA)

The most popular attachment method is the Pressure Sensitive Adhesive (PSA). Standard PSA are non conductive and are dimensioned to not cover the entire gasket surface to ensure direct electrical contact. The constraints applied on the adhesive vary in large proportions depending on the type of application. There are limited constraints for static applications because the adhesive is just there to hold the gasket the time before it will be compressed. At the contrary, for dynamic applications, constraints increase and especially when forces are exerted in the horizontal axis (for ex. during blade or module insertion) which tends to push the gasket. Schlegel Electronic Materials has selected 3M acrylic based adhesives with high shear strength values* to guarantee adhesions even in the most challenging dynamic applications.

To ensure the maximum bond strength from the adhesive, please follow the taping procedure.

| | T Tape | | | R Tape | | | H Tape | | |
|------------------------------|-----------------------------|-------|-------|--------------------|-------|-------|-----------------------------|-------|-------|
| Adhesive | Acrylic | | | Acrylic | | | Acrylic | | |
| Liner | Extensible polycoated kraft | | | Polycoated kraft | | | Extensible polycoated Kraft | | |
| Adhesive thickness | 5 mils (0.1270 mm) | | | 6.7 mils (0.17 mm) | | | 5 mils (0.1270 mm) | | |
| Substrate | No carrier | | | Polyester carrier | | | No carrier | | |
| Application | Pressure | | | Pressure | | | Pressure | | |
| LT operating temp. | 180°F(82.3°C) | | | 200°F(93.4°C) | | | 250°F(121°C) | | |
| ST operating temp. | 250°F(121°C) | | | 300°F(149°C) | | | 350°F(177°C) | | |
| Elongation | 8% | | | 3% | | | 8% | | |
| Shear/Stainless steel | Immediate | 24hrs | 72hrs | Immediate | 24hrs | 72hrs | Immediate | 24hrs | 72hrs |
| PSI | 14.7 | 34.8 | 47 | 17.4 | 45.7 | 50.7 | 17 | 39.4 | 48.3 |

Detailed 3M technical datasheet available on www.3M.com

Conductive adhesive can also be proposed and are recommended in specific instances (eg. very small profiles).

A) Taping procedure

Clean the metal surface with typical surface cleaner solvent. For example, use isopropyl alcohol or a heptane.

Wait until the bond surface is clean and dry because grease, oil or mold release chemicals could create a barrier between the adhesive and the substrate and hence affect the bond strength.

Wearing finger cots is suggested as a finger print is one of the contamination sources.



Remove release liner slowly and carefully. Do not allow the release liner to tear during removal. Confirm that no release liner remains on the adhesive. If the release liner tears and the remaining release liner cannot be easily removed, discard gasket and use a new gasket. Bond strength is dependent upon the amount of adhesive-to-surface contact developed. Dust, fiber or particle contamination will affect the tackiness of the adhesive and reduce the contact surface area.

Apply finger or hand pressure along the full length of gasket to completely bond to the metal surface. Confirm that pressure has been applied to both ends of the gasket to bond the adhesive to metal surface. Firm application pressure can develop a better adhesive contact and improve bond strength. The gasket and the tape can be used ONCE only. The gasket should not be peeled off and re-used again because the tape will lose its bond strength and will have adhesive issues.

The ideal tape application temperature range is 21°C to 38°C. Initial tape application to surfaces at temperatures below 10°C is not recommended as the adhesive will become too firm to adhere readily.

The bonding strength increases as a function of time. Time allows the adhesive flow on the substrate. In theory 72 hours dwell time is requested however about 2/3rd. of total adhesion strength is reached after 24 hours.

B) Adhesive removal

3M has developed a Citrus based Cleaner especially to ease the removal of adhesive residues. Further information can be found at www.3M.com



2. Rivets

Some profiles can be mounted using rivets. Plastic inserts are therefore positioned to reinforce the holes and ensure a good partition of the forces.

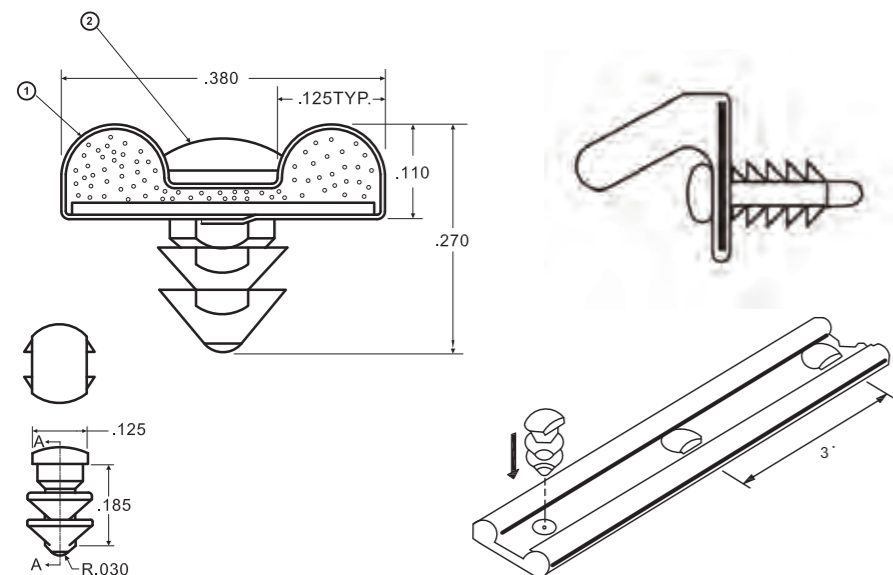

3. Clips

Several profiles with plastic clips are currently available. The conductive fabric is therefore positioned in the clip area to ensure electrical path.

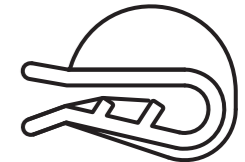
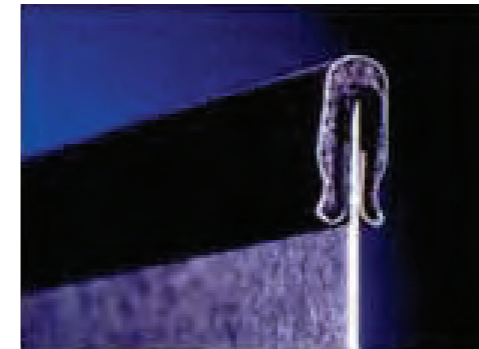

4. Self-mounting

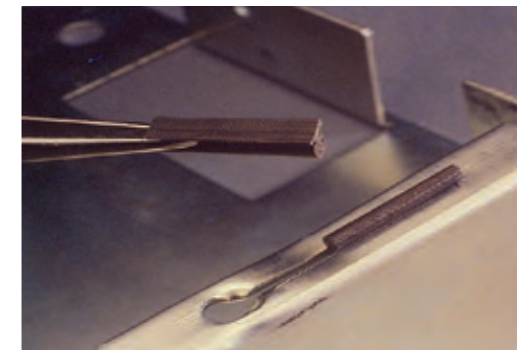

5. Kiss cut

